

Архангельск (8182)63-90-72
 Астана (7172)727-132
 Астрахань (8512)99-46-04
 Барнаул (3852)73-04-60
 Белгород (4722)40-23-64
 Брянск (4832)59-03-52
 Владивосток (423)249-28-31
 Волгоград (844)278-03-48
 Вологда (8172)26-41-59
 Воронеж (473)204-51-73
 Екатеринбург (343)384-55-89
 Иваново (4932)77-34-06

Ижевск (3412)26-03-58
 Иркутск (395)279-98-46
 Казань (843)206-01-48
 Калининград (4012)72-03-81
 Калуга (4842)92-23-67
 Кемерово (3842)65-04-62
 Киров (8332)68-02-04
 Краснодар (861)203-40-90
 Красноярск (391)204-63-61
 Курск (4712)77-13-04
 Липецк (4742)52-20-81

Магнитогорск (3519)55-03-13
 Москва (495)268-04-70
 Мурманск (8152)59-64-93
 Набережные Челны (8552)20-53-41
 Нижний Новгород (831)429-08-12
 Новокузнецк (3843)20-46-81
 Новосибирск (383)227-86-73
 Омск (3812)21-46-40
 Орел (4862)44-53-42
 Оренбург (3532)37-68-04
 Пенза (8412)22-31-16

Пермь (342)205-81-47
 Ростов-на-Дону (863)308-18-15
 Рязань (4912)46-61-64
 Самара (846)206-03-16
 Санкт-Петербург (812)309-46-40
 Саратов (845)249-38-78
 Севастополь (8692)22-31-93
 Симферополь (3652)67-13-56
 Смоленск (4812)29-41-54
 Сочи (862)225-72-31
 Ставрополь (8652)20-65-13

Сургут (3462)77-98-35
 Тверь (4822)63-31-35
 Томск (3822)98-41-53
 Тула (4872)74-02-29
 Тюмень (3452)66-21-18
 Ульяновск (8422)24-23-59
 Уфа (347)229-48-12
 Хабаровск (4212)92-98-04
 Челябинск (351)202-03-61
 Череповец (8202)49-02-64
 Ярославль (4852)69-52-93

Киргизия (996)312-96-26-47

Россия (495)268-04-70

Казахстан (772)734-952-31



PLASTIM ELEKTRİK was established in 2008 and today is among the leading manufacturers of ABS Electrical Panels, Electrical Panel Climatisation Products, Slotted Cable Ducts, Heaters etc. in Turkey. **PLASTIM** currently exports to more than 50 countries worldwide.

Its product range has also been constantly widened to suit the various requirements of its customers. It has a primary goal of providing customers with the best service in satisfying their industrial needs. To fulfil this purpose, the company always pushes to enhance its and research development (R&G) activities so that new products of high-quality can be added to its portfolio.





From Turkey to **worldwide**



Contents

POLYAMIDE & POLYPROPYLENE CONDUITS.....	5-8
CABLE TIES.....	9-12
INSULATED BUSBARS.....	13
CABLE MANAGEMENT.....	14-17
ALUMINUM POWER STRIP.....	18
ELECTRICAL DISTRIBUTION.....	19-23
VENTILATION.....	25-37
CONTROL.....	38-42
AIR CONDITIONING.....	43-44
THERMOELECTRIC COOLERS.....	45
HEATING.....	47-53
DISTRIBUTION BLOCKS.....	54-55
COPPER TUBULAR CABLE LUGS.....	56
DIN RAIL AND SUPPORTS.....	57
PET EXPANDABLE BRAIDED SLEEVING.....	58
CABLE TERMINALS.....	59-64
PBO PUSH BUTTON SERIES.....	65-69
CURRENT TRANSFORMER.....	70-73

POLYAMIDE & POLYPROPYLENE CONDUITS



POLYAMIDE and POLYPROPYLENE CONDUITS



Description:

Material: Polyamide 6
 Certificate: CE,
 Working Temperature: -40°C to 120°C
 Protection Class: IP 68
 Colour: Gray, black
 Properties: Flexible and excellent tenacity, resistant to oil, acid and solvents, anti-friction, black tubings are UV-resistant, Free of halogen, phosphor and cadmium.
 Application: Machine industry, automotive industry, robots, ship and railway industry.

POLYAMIDE CORRUGATED FLEXIBLE CONDUITS (PA6)

NOMINAL DIAMETER	CODE (Black)	CODE (Grey)	INSIDE DIA. (mm)	OUTSIDE DIA. (mm)	QUANTITY (m)
9	PS-PA09B	PS-PA09G	10,0	13,0	100
11	PS-PA11B	PS-PA11G	12,0	16,0	50
13.5	PS-PA13.5B	PS-PA13.5G	14,0	18,5	50
16	PS-PA16B	PS-PA16G	17,0	21,5	50
21	PS-PA21B	PS-PA21G	23,0	28,7	50
29	PS-PA29B	PS-PA29G	29,0	34,5	25
36	PS-PA36B	PS-PA36G	36,0	42,5	25
48	PS-PA48B	PS-PA48G	48,0	54,5	25



Description:

Material: Polypropylene
 Certificate: CE,
 Working Temperature: -40°C to 95°C
 Protection Class: IP 68
 Colour: Gray, black

POLYPROPYLENE CORRUGATED FLEXIBLE CONDUITS (PP)

NOMINAL DIAMETER	CODE (Black)	CODE (Grey)	INSIDE DIA. (mm)	OUTSIDE DIA. (mm)	QUANTITY (m)
9	PS-PP09B	PS-PP09G	10,0	13,0	100
11	PS-PP11B	PS-PP11G	12,0	16,0	50
13.5	PS-PP13.5B	PS-PP13.5G	14,0	18,5	50
16	PS-PP16B	PS-PP16G	17,0	21,5	50
21	PS-PP21B	PS-PP21G	23,0	28,7	50
29	PS-PP29B	PS-PP29G	29,0	34,5	25
36	PS-PP36B	PS-PP36G	36,0	42,5	25
48	PS-PP48B	PS-PP48G	48,0	54,5	25

QUICK CONNECTORS FOR CORRUGATED CONDUITS

PG TYPE QUICK CONNECTORS



Description:

Material: Poliamide 66

Certificate: CE , RoHS

Working Temperature: -40°C to 105°C

Protection Class: IP 65

Colour: Gray, black

Properties: Flame-retardant Self extinguishing, free of halogen, phosphor and cadmium

CODE (Black)	CODE (Grey)	CONDUIT CODE	CONDUIT SIZE (mm)	BOX QTY.
PD10-PG7B	PD10PG7G	PA7	6.5x10	100
PD12-PG7B	PD12-PG7G	PA8.5	8.5x12	75
PD13-PG9B	PD13-PG9G	PA9	10x13	50
PD15-PG11B	PD15-PG11G	PA11	12x15.8	50
PD18-PG13.5B	PD18-PG13.5G	PA13.5	14.2x18.4	75
PD21-PG16B	PD21-PG16G	PA16	16.5x21.2	50
PD28-PG21B	PD28-PG21G	PA21	23.5x28.4	25
PD34-PG29B	PD34-PG29G	PA29	29x34.5	20
PD42-PG36B	PD42-PG36G	PA36	36x42.5	15
PD54-PG48B	PD54-PG48G	PA48	48x54.5	10

METRIC TYPE QUICK CONNECTORS



Description:

Material: Poliamide 66

Certificate: CE , RoHS

Working Temperature: -40°C to 105°C

Protection Class: IP 65

Colour: Gray, black

Properties: Flame-retardant Self extinguishing, free of halogen, phosphor and cadmium

CODE (Black)	CODE (Grey)	CONDUIT CODE	CONDUIT SIZE (mm)	BOX QTY.
PD10-M12B	PD10-M12G	PA7	6.5X10	100
PD12-M12B	PD12-M12G	PA8.5	8.5x12	75
PD13-M16B	PD13-M16G	PA9	10x13	50
PD15-M16B	PD15-M16G	PA11	12x15.8	50
PD18-M20B	PD18-M20G	PA13.5	14.2x18.4	75
PD21-M20B	PD21-M20G	PA16	16.5x21.2	50
PD28-M25B	PD28-M25G	PA21	23.5x28.4	25
PD34-M32B	PD34-M32G	PA29	29x34.5	20
PD42-M40B	PD42-M40G	PA36	36x42.5	15
PD54-M63B	PD54-M63G	PA48	48x54.5	10

QUICK CONNECTORS FOR CORRUGATED CONDUITS

PG TYPE ELBOW CONNECTORS



Description:

Material: Poliamide 66

Certificate: CE , RoHS

Working Temperature: -40°C to 105°C

Protection Class: IP 65

Colour: Gray, black

Properties: Flame-retardant Self extinguishing, free of halogen, phosphor and cadmium

CODE (Black)	CODE (Grey)	CONDUIT CODE	CONDUIT SIZE (mm)	BOX QTY.
PDD10-PG7B	PDD10-PG7G	PA7	6.5x10	75
PDD13-PG9B	PDD13-PG9G	PA9	10x13	50
PDD15-PG11B	PDD15-PG11G	PA11	12x15.8	50
PDD18-PG13.5B	PDD18-PG13.5G	PA13.5	14.2x18.4	50
PDD21-PG16B	PDD21-PG16G	PA16	16.5x21.2	40
PDD28-PG21B	PDD28-PG21G	PA21	23.5x28.4	25
PDD34-PG29B	PDD34-PG29G	PA29	29x34.5	15
PDD42-PG36B	PDD42-PG36G	PA36	36x42.5	5
PDD54-PG48B	PDD54-PG48G	PA48	48x54.5	5

POLYAMIDE FLEXIBLE CONDUIT CLIPS



Description:

Material: Poliamide 66

Certificate: CE

Working Temperature: -40° to 105°C

Colour: Gray, black

CODE (Black)	CODE (Grey)	CONDUIT CODE	CONDUIT SIZE (mm)	BOX QTY.
PDBK13	PDGK13	PA9	13.0	50
PDBK15	PDGK15	PA11	15.8	50
PDBK18	PDGK18	PA13.5	18.4	50
PDBK21	PDGK21	PA16	21.2	50
PDBK28	PDGK28	PA21	28.4	25
PDBK34	PDGK34	PA29	34.5	25
PDBK42	PDGK42	PA36	42.5	25
PDBK54	PDGK54	PA48	54.5	10

CABLE TIES



CABLE TIES



CABLE TIES WHITE

CODE	SIZE(mm)	COLOUR	MAX. BUNDLE Ø (mm)	TENSILE STRENGHT (kg)	PACKAGE	BOX QTY
PKB-100M	2.5x100	WHITE	22	8	100	45.000
PKB-150M	2.5x150	WHITE	39	8	100	30.000
PKB-200M	2.5x200	WHITE	55	8	100	22.000
PKB-150I	3.6x150	WHITE	36	18	100	20.000
PKB-200I	3.6x200	WHITE	52	18	100	13.000
PKB-250I	3.6x250	WHITE	68	18	100	12.000
PKB-300I	3.6x292	WHITE	82	18	100	13.000
PKB-370I	3.6x368	WHITE	105	18	100	9.000
PKB-190S	4.8x190	WHITE	49	22	100	12.000
PKB-250S	4.8x250	WHITE	68	22	100	9.000
PKB-300S	4.8x300	WHITE	83	22	100	8.500
PKB-370S	4.8x368	WHITE	105	22	100	7.500
PKB-430S	4.8x432	WHITE	125	22	100	7.500
PKB-550S	4.8x550	WHITE	162	22	100	4.500
PKB-300H	7.6x300	WHITE	80	55	100	4.000
PKB-370H	7.6x370	WHITE	101	55	100	4.000
PKB-450H	8.0x450	WHITE	128	55	100	3.000
PKB-550H	8.0x550	WHITE	160	55	100	2.500
PKB-710H	9.0x710	WHITE	209	80	100	1.800
PKB-760H	9.0x762	WHITE	227	80	100	1.000
PKB-920H	9.0x914	WHITE	275	80	100	1.500

CABLE TIES



CABLE TIES BLACK

CODE	SIZE(mm)	COLOUR	MAX. BUNDLE Ø (mm)	TENSILE STRENGTH (kg)	PACKAGE	BOX QTY
PKB-100MB	2.5x100	BLACK	22	8	100	45.000
PKB-150MB	2.5x150	BLACK	39	8	100	30.000
PKB-200MB	2.5x200	BLACK	55	8	100	22.000
PKB-150IB	3.6x150	BLACK	36	18	100	20.000
PKB-200IB	3.6x200	BLACK	52	18	100	13.000
PKB-250IB	3.6x250	BLACK	68	18	100	12.000
PKB-300IB	3.6x292	BLACK	82	18	100	13.000
PKB-370IB	3.6x368	BLACK	105	18	100	9.000
PKB-190SB	4.8x190	BLACK	49	22	100	12.000
PKB-250SB	4.8x250	BLACK	68	22	100	9.000
PKB-300SB	4.8x300	BLACK	83	22	100	8.500
PKB-370SB	4.8x368	BLACK	105	22	100	7.500
PKB-430SB	4.8x432	BLACK	125	22	100	7.500
PKB-550SB	4.8x550	BLACK	162	22	100	4.500
PKB-300HB	7.6x300	BLACK	80	55	100	4.000
PKB-370HB	7.6x370	BLACK	101	55	100	4.000
PKB-450HB	8.0x450	BLACK	128	55	100	3.000
PKB-550HB	8.0x550	BLACK	160	55	100	2.500
PKB-710HB	9.0x710	BLACK	209	80	100	1.800
PKB-760HB	9.0x762	BLACK	227	80	100	1.000
PKB-920HB	9.0x914	BLACK	275	80	100	1.500

CABLE TIE ACCESSORIES

CABLE TIE ACCESSORIES



PRODUCT CODE	DESCRIPTION	PACKAGE QTY
PYK-1	Self Adhesive Mount 19x19 mm White	100
PYK-2	Self Adhesive Mount 28x28 mm White	100
PYK-1B	Self Adhesive Mount 19x19 mm Black	100
PYK-2B	Self Adhesive Mount 28x28 mm Black	100
PVK-1	Cable Tie Holder Screw Type 15x10x7 mm White	100
PVK-2	Cable Tie Holder Screw Type 23x16x10 mm White	100



DIN RAIL SOCKET

PRODUCT CODE	DESCRIPTION	PACKAGE QTY
PPR	DIN Rail Socket 16A	10

DIN RAIL TERMINAL BLOCK SYSTEMS

PRODUCT CODE	DESCRIPTION	PACKAGE QTY
PKD-03	DIN Rail end Stopper	50

INSULATED BUSBARS

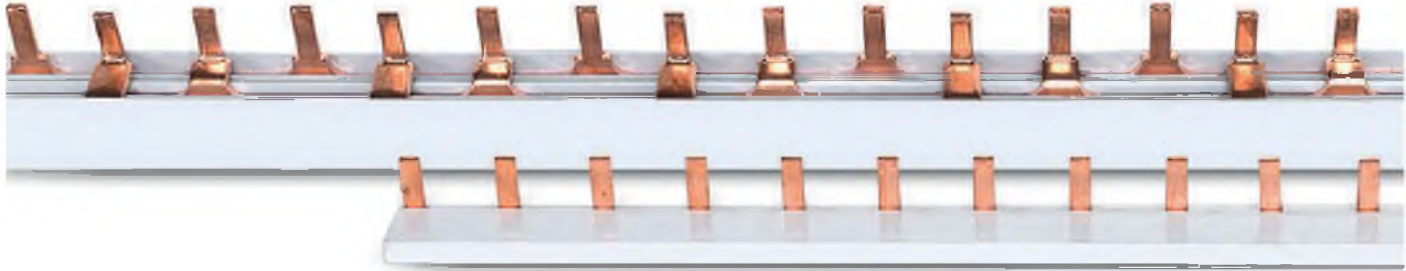

SINGLE PHASE INSULATED BUSBARS PIN TYPE

CODE	COPPER THICKNESS	LENGTH	MODUL	CURRENCY	DESCRIPTION	BOX QTY
PMB-0531	1 mm	53 cm	30	80 A	SINGLE PHASE INSULATED BUSBARS	25
PMB-1061	1 mm	106 cm	60	80 A	SINGLE PHASE INSULATED BUSBARS	25
PMB-0535	1.5 mm	53 cm	30	100 A	SINGLE PHASE INSULATED BUSBARS	25
PMB-1065	1.5 mm	106 cm	60	100 A	SINGLE PHASE INSULATED BUSBARS	25



THREE PHASE INSULATED BUSBARS PIN TYPE

CODE	COPPER THICKNESS	LENGTH	MODUL	CURRENCY	DESCRIPTION	BOX QTY
PTB-0531	1 mm	53 cm	30	80 A	THREE PHASE INSULATED BUSBARS	25
PTB-1061	1 mm	106 cm	60	80 A	THREE PHASE INSULATED BUSBARS	25
PTB-0535	1.5 mm	53 cm	30	100 A	THREE PHASE INSULATED BUSBARS	25
PTB-1065	1.5 mm	106 cm	60	100 A	THREE PHASE INSULATED BUSBARS	25
PTB-BK					PLASTIC END CAP FOR THREE PHASE BUSBARS	25

CABLE MANAGEMENT

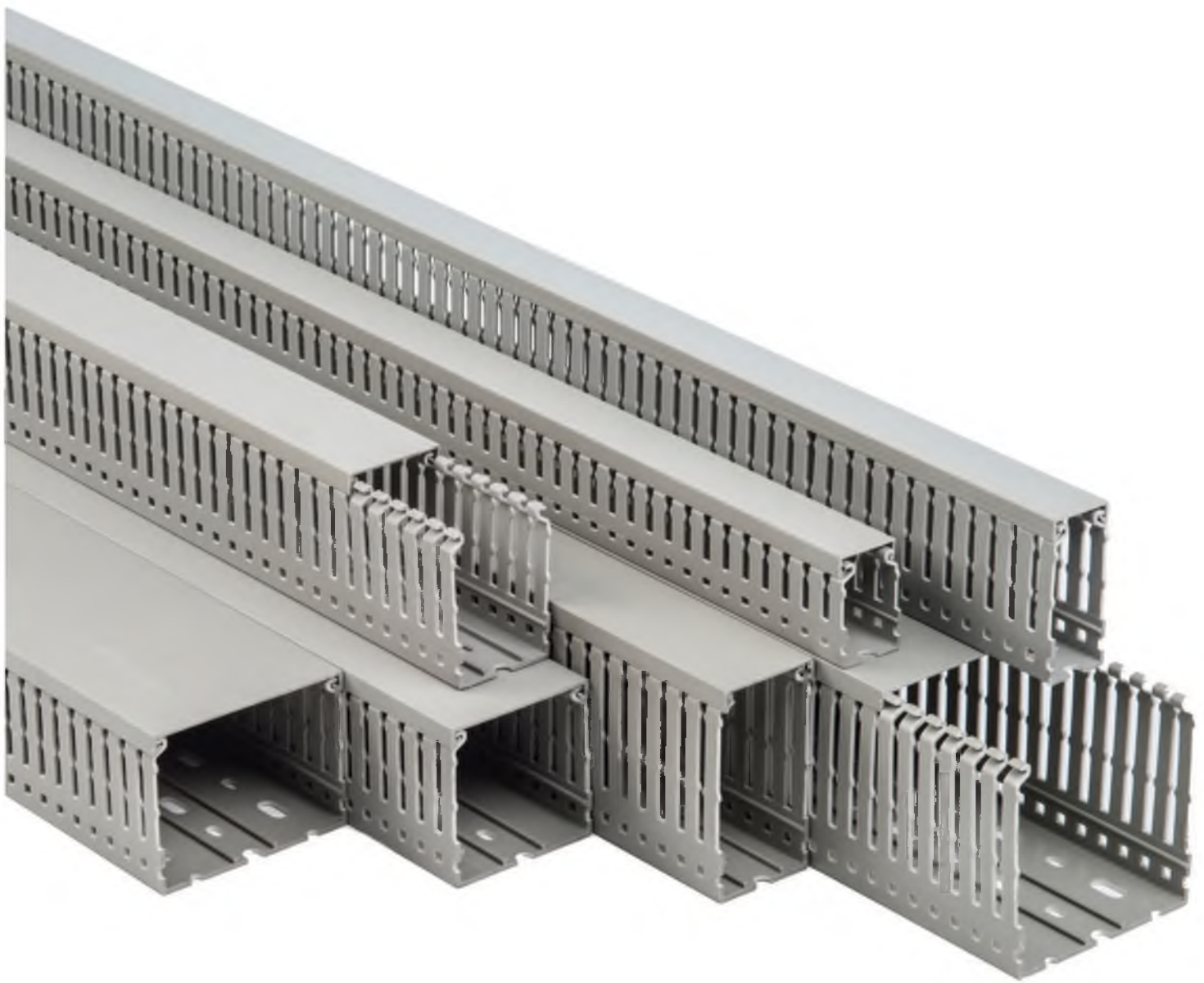



Upper Scorelines

The pre-scored upper lines at the base of the ducts provide easy breaking off the ribs as a result of 90 degree bending without using any hand tool.

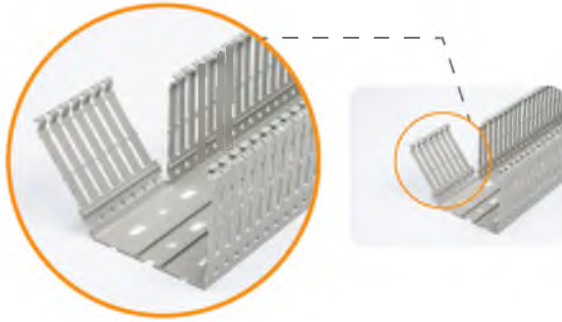

Lower Scorelines

Lower scorelines at the base enable to remove the whole trunking wall.

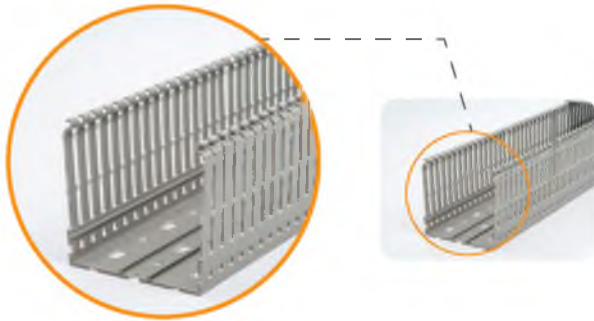

Bottom Rails

You can easily mount the accessories on the bottom rails of the duct.



Special Cover Design

The cover design lets you easily assemble and disassemble the cover regardless in whatever position the duct is installed.

PLASTİM PDK6060 RoHS CE EN50085 2-3 MADE IN TURKEY

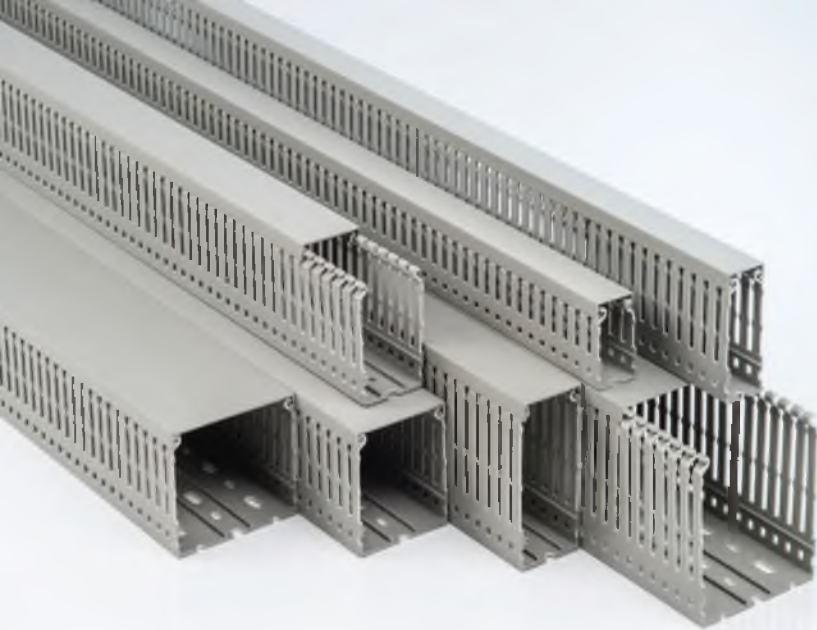

SLOTTED TYPE WIRING DUCTS

MAIN TECHNICAL FEATURES:

- Made of: technopolymer on rigid PVC base, self-extinguishing (UL94) V0
- Narrow slots 4/6/4mm + 5/8/5mm
- Perforated bottom according to the standard DIN 43659
- Standard bars length: 2m
- Reference Standards: EN 5085-2-3
- Packed in strong cardboard boxes suitable for transport and storage
- Standard colour RAL7030, other colours on request
- **CE** RoHS



SLOTTED WIRING DUCTS

Code	External Dimensions (mm)	Slot Range (mm)	Colour	Packaging
PDK 2530	25x30	4/6/4 mm	RAL 7030 Grey	60x2m
PDK 2540	25x40	4/6/4 mm	RAL 7030 Grey	64x2m
PDK 2560	25x60	4/6/4 mm	RAL 7030 Grey	48x2m
PDK 2580	25x80	4/6/4 mm	RAL 7030 Grey	32x2m
PDK 4040	40x40	4/6/4 mm	RAL 7030 Grey	35x2m
PDK 4060	40x60	4/6/4 mm	RAL 7030 Grey	30x2m
PDK 4080	40x80	4/6/4 mm	RAL 7030 Grey	20x2m
PDK 4010	40x100	5/8/5 mm	RAL 7030 Grey	20x2m
PDK 6040	60x40	4/6/4 mm	RAL 7030 Grey	25x2m
PDK 6060	60x60	4/6/4 mm	RAL 7030 Grey	24x2m
PDK 6080	60x80	4/6/4 mm	RAL 7030 Grey	16x2m
PDK 6010	60x100	5/8/5 mm	RAL 7030 Grey	16x2m
PDK 8060	80x60	4/6/4 mm	RAL 7030 Grey	14x2m
PDK 8080	80x80	4/6/4 mm	RAL 7030 Grey	12x2m
PDK 8010	80x100	5/8/5 mm	RAL 7030 Grey	12x2m
PDK 1060	100x60	4/6/4 mm	RAL 7030 Grey	10x2m
PDK 1080	100x80	4/6/4 mm	RAL 7030 Grey	10x2m
PDK 1010	100x100	5/8/5 mm	RAL 7030 Grey	8x2m
PDK 1260	120x60	4/6/4 mm	RAL 7030 Grey	10x2m
PDK 1280	120x80	4/6/4 mm	RAL 7030 Grey	8x2m

WIRING DUCT ACCESSORIES

WIRING DUCT COVERS

CODE	DIMENSIONS (mm)	COLOUR	PACKAGING
PDC 25	25	RAL 7030 Grey	50 Pcs
PDC 40	40	RAL 7030 Grey	50 Pcs
PDC 60	60	RAL 7030 Grey	50 Pcs
PDC 80	80	RAL 7030 Grey	50 Pcs
PDC 100	100	RAL 7030 Grey	50 Pcs
PDC 120	120	RAL 7030 Grey	50 Pcs



WIRING DUCT CUTTING TOOL

CODE	MAX. CUTTING SIZE	PACKAGING
PDC 110	60mm	1 Pc
PDC 250	150mm	1 Pc



PDC 110



PDC 250

ALUMINUM POWER STRIP

- 2 module= 1 electric socket
- Telephone satellite, Internet, on-off button can be attached.



Code	Dimensions (mm) (width x length x depth)	Product features
PGP-04B	65x142x50	4 Modul - 2 Electrical Socket
PGP-06B	65x187x50	6 Modul - 3 Electrical Socket
PGP-08B	65x232x50	8 Modul - 4 Electrical Socket
PGP-10B	65x277x50	10 Modul - 5 Electrical Socket
PGP-12B	65x322x50	12 Modul - 6 Electrical Socket
PGP-14B	65x365x50	14 Modul - 7 Electrical Socket
PGP-16B	65x412x50	16 Modul - 8 Electrical Socket



Code	Dimensions (mm)	Product features
PG-TPR-W	45x45	Child Protected White Earthed Electrical Socket
PG-TPR-B	45x45	Child Protected Black Earthed Electrical Socket
PG-UPS-R	45x45	Red UPS Socket Child Protection

ELECTRICAL DISTRIBUTION



PLASTIC DISTRIBUTION BOARDS GREY DOOR

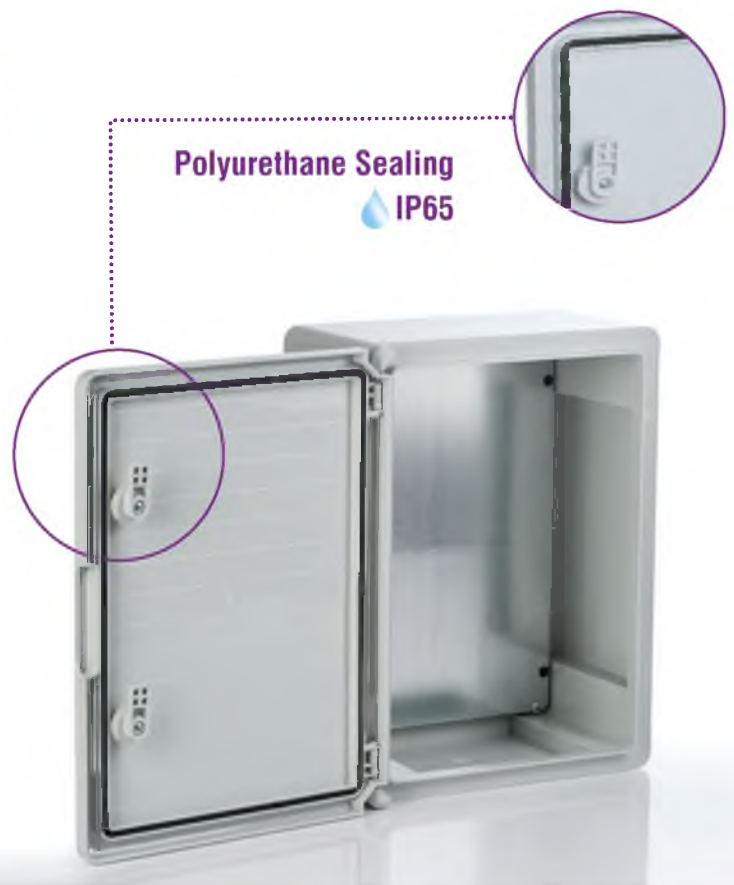

MAIN TECHNICAL FEATURES

- Resistance: Chemical agents, alkali, oils, salts, etc.
- Rated Voltage: Up to 690V
- Maximum Current: Up to 800A
- Operating Temperature: -35°C + 65°C
- Material: HB ABS
- Mounting Plate: Galvanised steel 1mm
- IP Degree: IP65
- IK Degree: IK08
- Colour: RAL7035 Grey (Other colours on request)
- **CE** RoHS



Polyurethane Sealing  IP65



PLASTIC DISTRIBUTION BOARDS - GREY DOOR

CODE	L (mm)	W (mm)	H (mm)	WEIGHT(kg)
PP3001	200	300	130	1.70
PP3002	250	350	150	2.20
PP3004	300	400	170	3.00
PP3005	300	400	220	3.40
PP3006	350	500	190	4.30
PP3003	400	500	175	4.30
PP3007	400	500	240	5.60
PP3008	400	600	200	6.00
PP3010	500	700	250	10.10
PP3021	600	800	260	13.50

PLASTIC DISTRIBUTION BOARDS TRANSPARENT DOOR

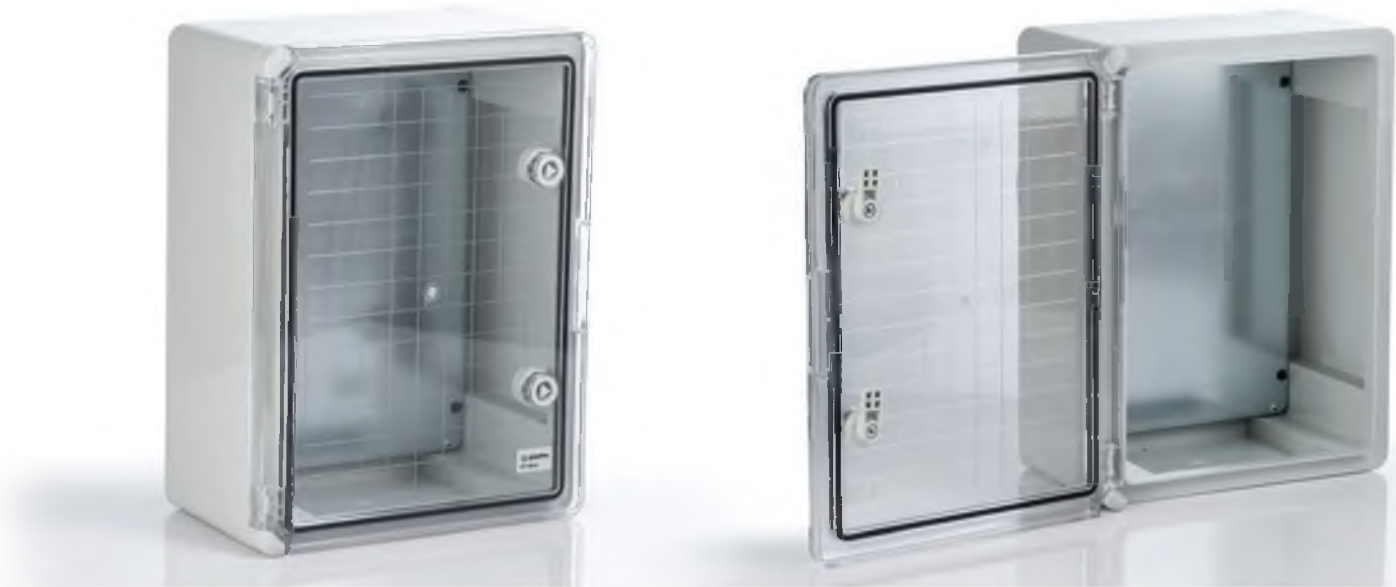

MAIN TECHNICAL FEATURES

- Resistance: Chemical agents, alkali, oils, salts, etc.
- Rated Voltage: Up to 690V
- Maximum Current: Up to 800A
- Operating Temperature: -35°C + 65°C
- Material: HB ABS + Polycarbonate (Doors)
- Mounting Plate: Galvanised steel 1mm
- IP Degree: IP65
- IK Degree: IK08
- Colour: RAL7035 Grey body, transparent door (Other colours on request)
- **CE** RoHS



Polyurethane
Sealing

 IP65

CE

PLASTIC DISTRIBUTION BOARDS - TRANSPARENT DOOR

CODE	L (mm)	W (mm)	H (mm)	WEIGHT(kg)
PP3011	200	300	130	1.70
PP3012	250	350	150	2.20
PP3014	300	400	170	3.00
PP3015	300	400	220	3.40
PP3016	350	500	190	4.30
PP3013	400	500	175	4.30
PP3017	400	500	240	5.60
PP3018	400	600	200	6.00
PP3020	500	700	250	10.10
PP3022	600	800	260	13.50

MODULAR DISTRIBUTION BOARDS GREY DOOR

Polyurethane Sealing
IP65



MAIN TECHNICAL FEATURES

- Resistance: Chemical agents, alkali, oils, salts, etc.
- Rated Voltage: Up to 690V
- Maximum Current: Up to 800A
- Operating Temperature: -35°C + 65°C
- Material: HB ABS
- IP Degree: IP65
- IK Degree: IK08
- Colour: RAL7035 Grey (Other colours on request)
- **CE** RoHS



Polyurethane Sealing IP65



MODULAR DISTRIBUTION BOARDS - GREY DOOR

CODE	L (mm)	W (mm)	H (mm)	MCB Qty	WEIGHT(kg)
PP3102	250	350	150	18 (9x2)	2.50
PP3104	300	400	170	24 (12x2)	3.40
PP3106	350	500	190	45 (15x3)	4.50
PP3108	400	600	200	60 (15x4)	6.00

MODULAR DISTRIBUTION BOARDS TRANSPARENT DOOR



MAIN TECHNICAL FEATURES

- Resistance: Chemical agents, alkali, oils, salts, etc.
- Rated Voltage: Up to 690V
- Maximum Current: Up to 800A
- Operating Temperature: -35°C + 65°C
- Material: HB ABS + Polycarbonate (Doors)
- IP Degree: IP65
- IK Degree: IK08
- Colour: RAL7035 Grey body, transparent door (Other colours on request)
- **CE** RoHS



Polyurethane
Sealing



MODULAR DISTRIBUTION BOARDS - TRANSPARENT DOOR

CODE	L (mm)	W (mm)	H (mm)	MCB Qty	WEIGHT(kg)
PP3112	250	350	150	18 (9x2)	2.50
PP3114	300	400	170	24 (12x2)	3.40
PP3116	350	500	190	45 (15x3)	4.50
PP3118	400	600	200	60 (15x4)	6.00

PRODUCTS

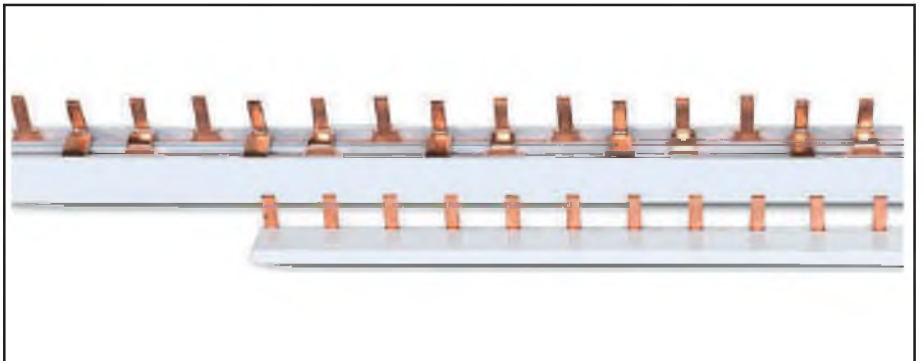

 **plastim**[®]
The Art ⚡ Of Electricity

VENTILATION





ROOF FANS

MODELS	UNIT	PFF4000	PFF5500	PFF6000
AIR FLOW RATE	m ³ /h	400	560	970
POWER SUPPLY	V/Hz	230V 50-60Hz	230V 50-60Hz	230V 50-60Hz
DIMENSIONS	mm	364x364x107	364x364x107	364x364x107
POWER CONSUMPTION	W	25/32	58/75	85/90
CURRENT CONSUMPTION	A	0.11/0,15	0.26/0.34	0.38/0.44
OVERCURRENT PROTECTION	-	THERMAL	THERMAL	THERMAL
ELECTRICAL CONNECTION	-	3-POLE TERMINAL 2.5mm ²	4-POLE TERMINAL 2.5mm ²	4-POLE TERMINAL 2.5mm ²
OPERATING TEMPERATURE	°C	-10/+70	-10/+70	-10/+70
PROTECTION DEGREE	-	IP54	IP54	IP54
NOISE LEVEL	dB(A)	57(61)	62 (64)	72 (73)
FLOW DIRECTION	-	INSIDE / OUT	INSIDE / OUT	INSIDE / OUT
BEARING	-	BALL	BALL	BALL
SERVICE LIFE	Hour	50.000	50.000	50.000
PLASTIC MATERIAL	-	UL94 V0 ABS FLAME RETARDANT	UL94 V0 ABS FLAME RETARDANT	UL94 V0 ABS FLAME RETARDANT
GASKET	-	POLYURETHANE SEALING	POLYURETHANE SEALING	POLYURETHANE SEALING
WEIGHT	kg	2.68	3.16	3.74
MOUNTING	-	8 PCS M4 SCREWS	8 PCS M4 SCREWS	8 PCS M4 SCREWS
CONFORMITY	-	CE	CE	CE

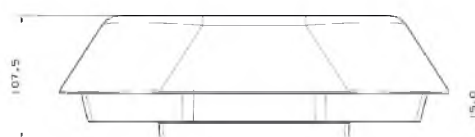
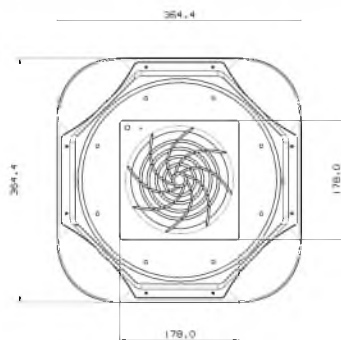



ROOF FANS

MODELS	UNIT	PFF4000G	PFF5500G	PFF6000G
AIR FLOW RATE	m ³ /h	400	560	970
POWER SUPPLY	V/Hz	230V 50-60Hz	230V 50-60Hz	230V 50-60Hz
DIMENSIONS	mm	364x364x107	364x364x107	364x364x107
POWER CONSUMPTION	W	25/32	58/75	85/90
CURRENT CONSUMPTION	A	0.11/0.15	0.26/0.34	0.38/0.44
OVERCURRENT PROTECTION	-	THERMAL	THERMAL	THERMAL
ELECTRICAL CONNECTION	-	3-POLE TERMINAL 2.5mm ²	4-POLE TERMINAL 2.5mm ²	4-POLE TERMINAL 2.5mm ²
OPERATING TEMPERATURE	°C	-10/+70	-10/+70	-10/+70
PROTECTION DEGREE	-	IP54	IP54	IP54
NOISE LEVEL	dB(A)	57(61)	62 (64)	72 (73)
FLOW DIRECTION	-	INSIDE / OUT	INSIDE / OUT	INSIDE / OUT
BEARING	-	BALL	BALL	BALL
SERVICE LIFE	Hour	50.000	50.000	50.000
PLASTIC MATERIAL	-	UL94 V0 ABS FLAME RETARDANT	UL94 V0 ABS FLAME RETARDANT	UL94 V0 ABS FLAME RETARDANT
GASKET	-	POLYURETHANE SEALING	POLYURETHANE SEALING	POLYURETHANE SEALING
WEIGHT	kg	2.68	3.16	3.74
MOUNTING	-	FAST CLIP ON	FAST CLIP ON	FAST CLIP ON
CONFORMITY	-	CE	CE	CE

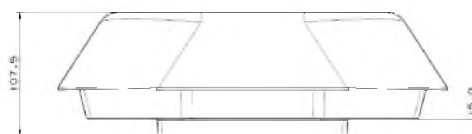
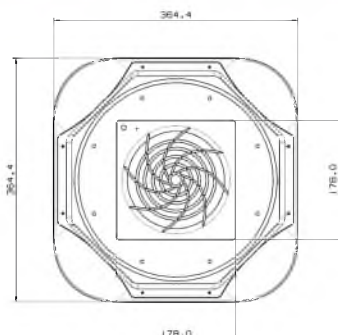



ROOF FANS

MODELS	UNIT	PTS4000	PTS5500	PTS6000
AIR FLOW RATE	m ³ /h	400	560	970
POWER SUPPLY	V/Hz	230V 50-60Hz	230V 50-60Hz	230V 50-60Hz
DIMENSIONS	mm	364x364x107	364x364x107	364x364x107
POWER CONSUMPTION	W	25/32	58/75	85/90
CURRENT CONSUMPTION	A	0.11/0.15	0.26/0.34	0.38/0.44
OVERCURRENT PROTECTION	-	THERMAL	THERMAL	THERMAL
ELECTRICAL CONNECTION	-	3-POLE TERMINAL 2.5mm ²	3-POLE TERMINAL 2.5mm ²	3-POLE TERMINAL 2.5mm ²
OPERATING TEMPERATURE	°C	-10/+70	-10/+70	-10/+70
PROTECTION DEGREE	-	IP54	IP54	IP54
NOISE LEVEL	dB(A)	62 (64)	62 (64)	72 (73)
FLOW DIRECTION	-	INSIDE / OUT	INSIDE / OUT	INSIDE / OUT
BEARING	-	BALL	BALL	BALL
SERVICE LIFE	Hour	50.000	50.000	50.000
PLASTIC MATERIAL	-	UL94 V0 ABS FLAME RETARDANT	UL94 V0 ABS FLAME RETARDANT	UL94 V0 ABS FLAME RETARDANT
GASKET	-	POLYURETHANE SEALING	POLYURETHANE SEALING	POLYURETHANE SEALING
WEIGHT	kg	2.60	3.16	3.74
MOUNTING	-	FAST CLIP ON	FAST CLIP ON	FAST CLIP ON
CONFORMITY	-	CE	CE	CE

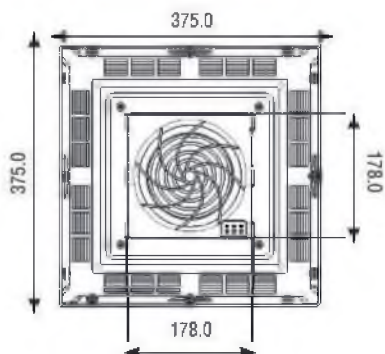



PFI1000



PTF1000



PTF1000T

New
FILTER FANS
30m³/h

MODELS	UNIT	PFI1000	PTF1000	PTF1000T
AIR FLOW RATE	m ³ /h	-	30 (41)	30 (41)
POWER SUPPLY	V/Hz	-	230V 50-60Hz	230V 50-60Hz
DIMENSIONS	mm	120x120x20.5	120x120x58.5	120x120x58.5
POWER CONSUMPTION	W	-	14 (13)	14 (13)
CURRENT CONSUMPTION	A	-	0.08/0.07	0.08/0.07
OVERCURRENT PROTECTION	-	-	IMPEDANCE	IMPEDANCE
ELECTRICAL CONNECTION	-	-	LEAD WIRE	3-POLE TERMINAL 2.5mm ²
OPERATING TEMPERATURE	°C	-10/+70	-10/+70	-10/+70
PROTECTION DEGREE	-	IP54	IP54 / CLASS I	IP54 / CLASS I
NOISE LEVEL	dB(A)	62 (64)	28 (31)	28 (31)
FLOW DIRECTION	-	-	OUTSIDE-IN	OUTSIDE-IN
BEARING	-	-	SLEEVE	SLEEVE
PLASTIC MATERIAL	-	UL94 V0 ABS FLAME RETARDANT	UL94 V0 ABS FLAME RETARDANT	UL94 V0 ABS FLAME RETARDANT
GASKET	-	SELF-ADHESIVE	SELF-ADHESIVE	SELF-ADHESIVE
COLOR	-	RAL7035 (RAL7032 ON REQUEST)	RAL7035 (RAL7032 ON REQUEST)	RAL7035 (RAL7032 ON REQUEST)
WEIGHT	kg	0.10	0.40	0.40
MOUNTING	-	FAST CLIP ON	FAST CLIP ON	FAST CLIP ON
CONFORMITY	-	CE	CE	CE

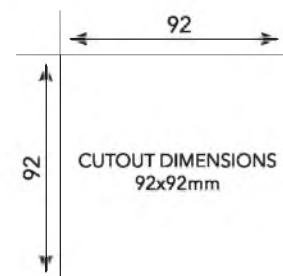
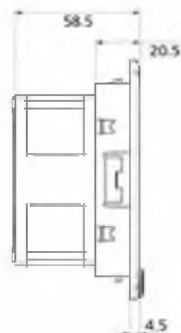
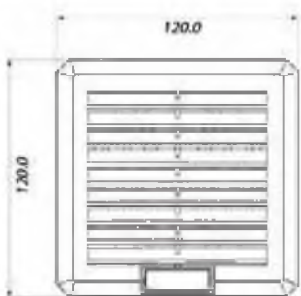



PFI1500



PTF1500



PTF1500T



Filter FANS
100 m³/h

MODELS	UNIT	PFI1500	PTF1500	PTF1500T
AIR FLOW RATE	m ³ /h	-	100(140)	100(140)
POWER SUPPLY	V/Hz	-	230V 50-60Hz	230V 50-60Hz
DIMENSIONS	mm	160x160x31	160x160x69	160x160x69
POWER CONSUMPTION	W	-	26 (23)	26 (23)
CURRENT CONSUMPTION	A	-	0.14/0.13	0.14/0.13
OVERCURRENT PROTECTION	-	-	IMPEDANCE	IMPEDANCE
ELECTRICAL CONNECTION	-	-	LEAD WIRE	3-POLE TERMINAL 2.5mm ²
OPERATING TEMPERATURE	°C	-10/+70	-10/+70	-10/+70
PROTECTION DEGREE	-	IP54	IP54 / CLASS I	IP54 / CLASS I
NOISE LEVEL	dB(A)	-	42 (46)	42 (46)
FLOW DIRECTION	-	-	OUTSIDE-IN	OUTSIDE-IN
BEARING	-	-	BALL	BALL
PLASTIC MATERIAL	-	UL94 V0 ABS FLAME RETARDANT	UL94 V0 ABS FLAME RETARDANT	UL94 V0 ABS FLAME RETARDANT
GASKET	-	POLYURETHANE SEALING	POLYURETHANE SEALING	POLYURETHANE SEALING
COLOR	-	RAL7035 (RAL7032 ON REQUEST)	RAL7035 (RAL7032 ON REQUEST)	RAL7035 (RAL7032 ON REQUEST)
WEIGHT	kg	0.18	0.68	0.68
MOUNTING	-	FAST CLIP ON	FAST CLIP ON	FAST CLIP ON
CONFORMITY	-	CE	CE	CE

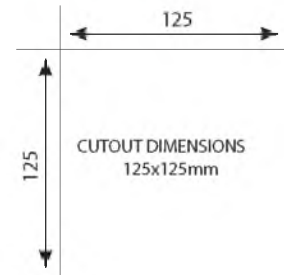
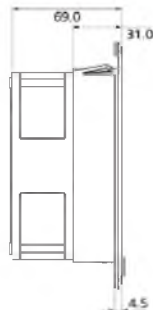
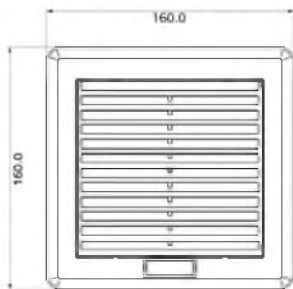



PFI2000



PTF2000



PTF2000



FILTER FANS

125m³/h

MODELS	UNIT	PFI2000	PTF2000
AIR FLOW RATE	m ³ /h	-	125 (175)
POWER SUPPLY	V/Hz	-	230V 50-60Hz
DIMENSIONS	mm	210x210x31	210x210x98
POWER CONSUMPTION	W	-	26 (23)
CURRENT CONSUMPTION	A	-	0.14/0.13
OVERCURRENT PROTECTION	-	-	IMPEDANCE
ELECTRICAL CONNECTION	-	-	3-POLE TERMINAL
OPERATING TEMPERATURE	°C	-10/+70	-10/+70
PROTECTION DEGREE	-	IP54	IP54 / CLASS I
NOISE LEVEL	dB(A)	-	42 (46)
FLOW DIRECTION	-	-	OUTSIDE-IN
BEARING	-	-	BALL
PLASTIC MATERIAL	-	UL94 V0 ABS FLAME RETARDANT	UL94 V0 ABS FLAME RETARDANT
GASKET	-	POLYURETHANE SEALING	POLYURETHANE SEALING
COLOUR	-	RAL7035 (RAL7032 ON REQUEST)	RAL7035 (RAL7032 ON REQUEST)
WEIGHT	kg	0.35	1.05
MOUNTING	-	FAST CLIP-ON	FAST CLIP-ON
CONFORMITY	-	CE	CE

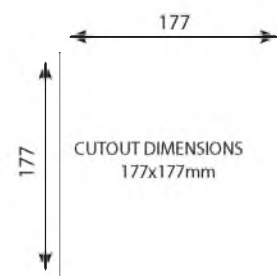
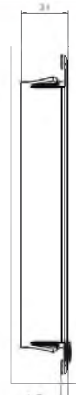
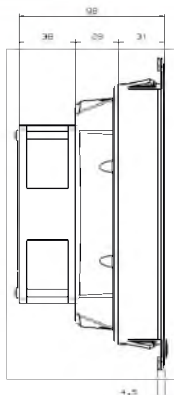
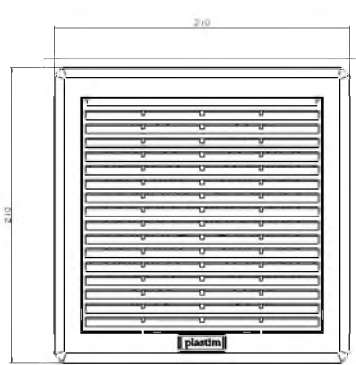



PFI2000



PTF3000



PTF3000

New
FILTER FANS
175m³/h

MODELS	UNIT	PFI2000	PTF3000
AIR FLOW RATE	m ³ /h	-	175 (245)
POWER SUPPLY	V/Hz	-	230V 50-60Hz
DIMENSIONS	mm	210x210x31	210x210x92
POWER CONSUMPTION	W	-	37 (35)
CURRENT CONSUMPTION	A	-	0.23/0.22
OVERCURRENT PROTECTION	-	-	IMPEDANCE
ELECTRICAL CONNECTION	-	-	3-POLE TERMINAL
OPERATING TEMPERATURE	°C	-10/+70	-10/+70
PROTECTION DEGREE	-	IP54	IP54 / CLASS I
NOISE LEVEL	dB(A)	-	52 (53)
FLOW DIRECTION	-	-	OUTSIDE-IN
BEARING	-	-	BALL
PLASTIC MATERIAL	-	UL94 V0 ABS FLAME RETARDANT	UL94 V0 ABS FLAME RETARDANT
GASKET	-	POLYURETHANE SEALING	POLYURETHANE SEALING
COLOUR	-	RAL7035 (RAL7032 ON REQUEST)	RAL7035 (RAL7032 ON REQUEST)
WEIGHT	kg	0.35	1.45
MOUNTING	-	FAST CLIP-ON	FAST CLIP-ON
CONFORMITY	-	CE	CE

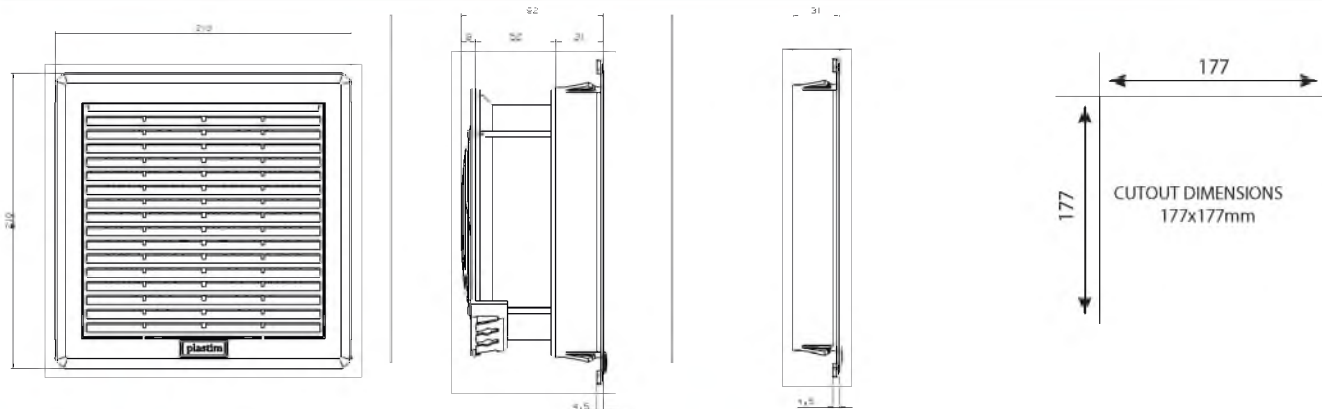



PFI2500



PTF2500



PTF2500

FILTER FANS

115m³/h

MODELS	UNIT	PFI2500	PTF2500
AIR FLOW RATE	m ³ /h	-	115 (130)
POWER SUPPLY	V/Hz	-	230V 50-60Hz
DIMENSIONS	mm	260x260x31	260x260x103
POWER CONSUMPTION	W	-	26 (23)
CURRENT CONSUMPTION	A	-	0.14/0.13
OVERCURRENT PROTECTION	-	-	IMPEDANCE
ELECTRICAL CONNECTION	-	-	3-POLE TERMINAL
OPERATING TEMPERATURE	°C	-10/+70	-10/+70
PROTECTION DEGREE	-	IP54	IP54 / CLASS I
NOISE LEVEL	dB(A)	-	42 (46)
FLOW DIRECTION	-	-	OUTSIDE-IN
BEARING	-	-	BALL
PLASTIC MATERIAL	-	UL94 V0 ABS FLAME RETARDANT	UL94 V0 ABS FLAME RETARDANT
GASKET	-	POLYURETHANE SEALING	POLYURETHANE SEALING
COLOUR	-	RAL7035 (RAL7032 ON REQUEST)	RAL7035 (RAL7032 ON REQUEST)
WEIGHT	kg	0.48	1.18
MOUNTING	-	FAST CLIP-ON	FAST CLIP-ON
CONFORMITY	-	CE	CE

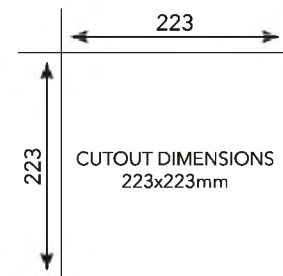
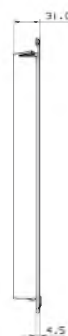
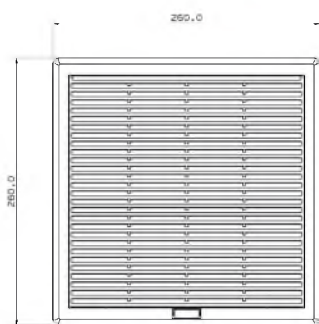



PFI2500



PTF3500



PTF3500

FILTER FANS

240m³/h

MODELS	UNIT	PFI2500	PTF3500
AIR FLOW RATE	m ³ /h	-	240 (270)
POWER SUPPLY	V/Hz	-	230V 50-60Hz
DIMENSIONS	mm	260x260x31	260x260x103
POWER CONSUMPTION	W	-	37 (35)
CURRENT CONSUMPTION	A	-	0.23/0.22
OVERCURRENT PROTECTION	-	-	IMPEDANCE
ELECTRICAL CONNECTION	-	-	3-POLE TERMINAL
OPERATING TEMPERATURE	°C	-10/+70	-10/+70
PROTECTION DEGREE	-	IP54	IP54 / CLASS I
NOISE LEVEL	dB(A)	-	52 (53)
FLOW DIRECTION	-	-	OUTSIDE-IN
BEARING	-	-	BALL
PLASTIC MATERIAL	-	UL94 V0 ABS FLAME RETARDANT	UL94 V0 ABS FLAME RETARDANT
GASKET	-	POLYURETHANE SEALING	POLYURETHANE SEALING
COLOUR	-	RAL7035 (RAL7032 ON REQUEST)	RAL7035 (RAL7032 ON REQUEST)
WEIGHT	kg	0.48	1.60
MOUNTING	-	FAST CLIP-ON	FAST CLIP-ON
CONFORMITY	-	CE	CE

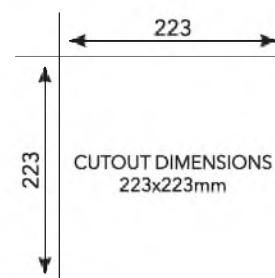
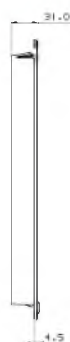
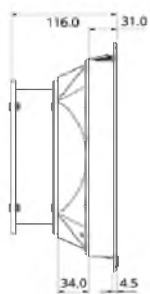
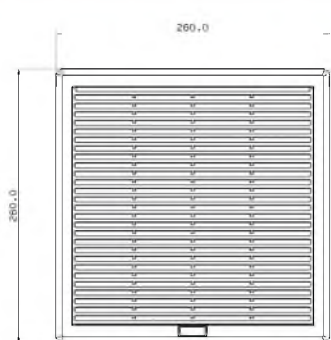



PFI2500



PTF4500



PTF4500

FILTER FANS

650m³/h

MODELS	UNIT	PFI2500	PTF4500
AIR FLOW RATE	m ³ /h	-	650 (900)
POWER SUPPLY	V/Hz	-	230V 50-60Hz
DIMENSIONS	mm	260x260x31	260x260x111
POWER CONSUMPTION	W	-	66 (75)
CURRENT CONSUMPTION	A	-	0.35/0.38
OVERCURRENT PROTECTION	-	-	THERMAL
ELECTRICAL CONNECTION	-	-	4-POLE TERMINAL
OPERATING TEMPERATURE	°C	-10/+70	-10/+70
PROTECTION DEGREE	-	IP54	IP54 / CLASS I
NOISE LEVEL	dB(A)	-	60 (63)
FLOW DIRECTION	-	-	OUTSIDE-IN
BEARING	-	-	BALL
PLASTIC MATERIAL	-	UL94 V0 ABS FLAME RETARDANT	UL94 V0 ABS FLAME RETARDANT
GASKET	-	POLYURETHANE SEALING	POLYURETHANE SEALING
COLOUR	-	RAL7035 (RAL7032 ON REQUEST)	RAL7035 (RAL7032 ON REQUEST)
WEIGHT	kg	0.48	2.84
MOUNTING	-	FAST CLIP-ON	FAST CLIP-ON
CONFORMITY	-	CE	CE

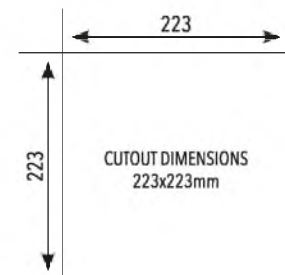
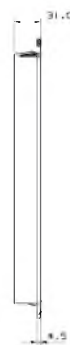
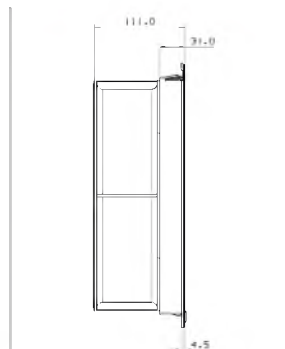
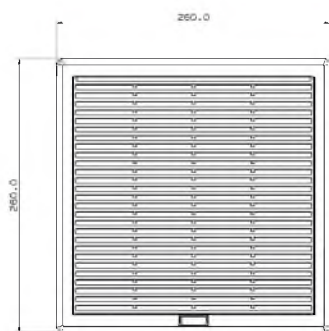



PFI3000



PTF4700



PTF4700

New
FILTER FANS
700m³/h

MODELS	UNIT	PFI3000	PTF4700
AIR FLOW RATE	m ³ /h	-	700 (950)
POWER SUPPLY	V/Hz	-	230V 50-60Hz
DIMENSIONS	mm	325x325x31	325x325x145
POWER CONSUMPTION	W	-	66 (75)
CURRENT CONSUMPTION	A	-	0.35/0.38
OVERCURRENT PROTECTION	-	-	THERMAL
ELECTRICAL CONNECTION	-	-	4-POLE TERMINAL
OPERATING TEMPERATURE	°C	-10/+70	-10/+70
PROTECTION DEGREE	-	IP54	IP54 / CLASS I
NOISE LEVEL	dB(A)	-	60 (63)
FLOW DIRECTION	-	-	OUTSIDE-IN
BEARING	-	-	BALL
PLASTIC MATERIAL	-	UL94 V0 ABS FLAME RETARDANT	UL94 V0 ABS FLAME RETARDANT
GASKET	-	POLYURETHANE SEALING	POLYURETHANE SEALING
COLOUR	-	RAL7035 (RAL7032 ON REQUEST)	RAL7035 (RAL7032 ON REQUEST)
WEIGHT	kg	0.70	4.12
MOUNTING	-	FAST CLIP-ON	FAST CLIP-ON
CONFORMITY	-	CE	CE

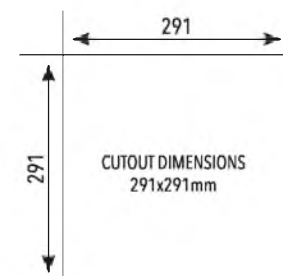
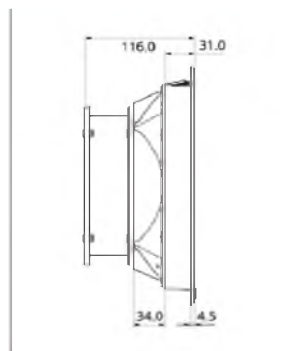
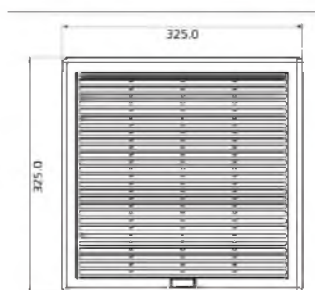



PFI3000



PTF5000



PTF5000

FILTER FANS

850m³/h

MODELS	UNIT	PFI3000	PTF5000
AIR FLOW RATE	m ³ /h	-	850 (1200)
POWER SUPPLY	V/Hz	-	230V 50-60Hz
DIMENSIONS	mm	325x325x31	325x325x111
POWER CONSUMPTION	W	-	110 (140)
CURRENT CONSUMPTION	A	-	0.350/0.72
OVERCURRENT PROTECTION	-	-	THERMAL
ELECTRICAL CONNECTION	-	-	4-POLE TERMINAL
OPERATING TEMPERATURE	°C	-10/+70	-10/+70
PROTECTION DEGREE	-	IP54	IP54 / CLASS I
NOISE LEVEL	dB(A)	-	65 (68)
FLOW DIRECTION	-	-	OUTSIDE-IN
BEARING	-	-	BALL
PLASTIC MATERIAL	-	UL94 V0 ABS FLAME RETARDANT	UL94 V0 ABS FLAME RETARDANT
GASKET	-	POLYURETHANE SEALING	POLYURETHANE SEALING
COLOUR	-	RAL7035 (RAL7032 ON REQUEST)	RAL7035 (RAL7032 ON REQUEST)
WEIGHT	kg	0.70	4.12
MOUNTING	-	FAST CLIP-ON	FAST CLIP-ON
CONFORMITY	-	CE	CE

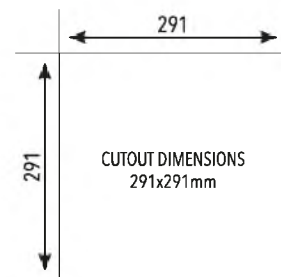
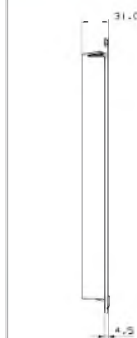
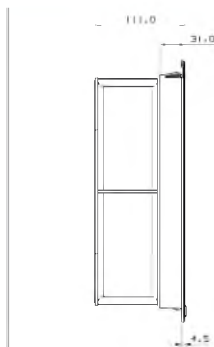
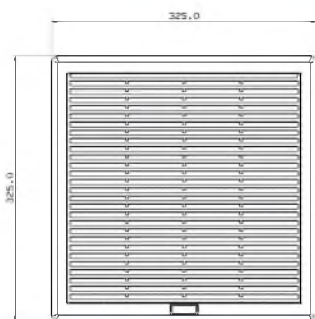

CONTROL







TEMPERATURE CONTROL THERMOSTATS

MODELS	UNIT	PTHT	PTVT
CONTACT FUNCTION	-	NC	NO
TEMPERATURE SETTING RANGE	°C	0-60	0-60
COLOUR OF POTENTIOMETER	-	RED	BLUE
250V AC / 120V AC	A	10 (2)	15 (2)
SENSOR TYPE	-	BIMETAL	
CONTACT TYPE	-	SNAP ACTION	
SERVICE LIFE	Cycle	> 100.000	
ELECTRICAL CONNECTIONS	-	2-POLE TERMINAL	
PLASTIC MATERIAL	-	UL94 V0 ABS FLAME RETARDANT	
PROTECTION DEGREE	EN60529	IP20	
OPERATING TEMPERATURE	°C	-25 / +80	
STORAGE TEMPERATURE	°C	-45 / +80	
MOUNTING	-	CLIP FOR MOUNTING on DIN RAIL 35mm	
INSTALLATION POSITION	-	VARIABLE	
CONFORMITY	-	CE	
DIMENSIONS HxWxD	mm	61x34x38	
WEIGHT	g	45	

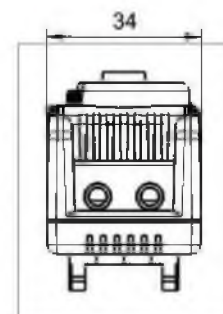
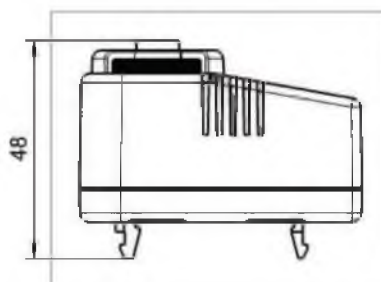
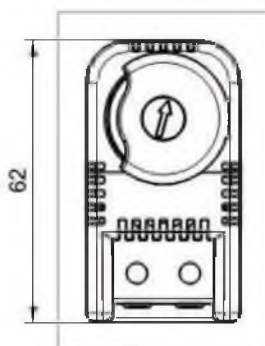



TEMPERATURE CONTROL DUAL THERMOSTAT

MODELS	UNIT	PTHVT
CONTACT FUNCTION	-	NC+NO
TEMPERATURE SETTING RANGE	°C	0-60 / 0-60
COLOUR OF POTENTIOMETER	-	RED + BLUE
250V AC / 120V AC	A	10 (2) / 15 (2)
SENSOR TYPE	-	BIMETAL
CONTACT TYPE	-	SNAP ACTION
SERVICE LIFE	Cycle	> 100.000
ELECTRICAL CONNECTIONS	-	4-POLE TERMINAL
PLASTIC MATERIAL	-	UL94 V0 ABS FLAME RETARDANT
PROTECTION DEGREE	EN60529	IP20
OPERATING TEMPERATURE	°C	-25 / +80
STORAGE TEMPERATURE	°C	-45 / +80
MOUNTING	-	CLIP FOR MOUNTING on DIN RAIL 35mm
INSTALLATION POSITION	-	VARIABLE
CONFORMITY	-	CE
DIMENSIONS HxWxD	mm	65x59x42
WEIGHT	g	80

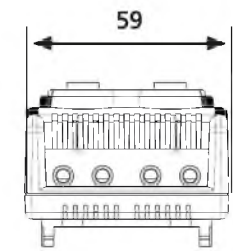
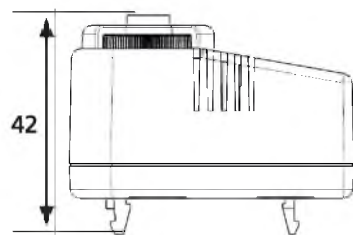
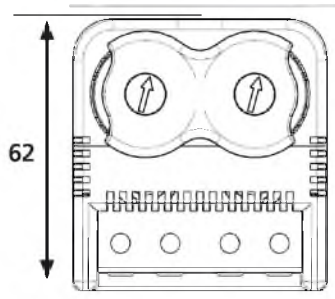



HUMIDITY CONTROL MECHANICAL HYGROSTAT

MODELS	UNIT	PHG02
POWER SUPPLY	V AC	110-250
SETTING RANGE	%RH	10-90
COLOUR OF POTENTIOMETER	-	BLACK
CURRENT	A	10-5
DIFFERENTIAL	-	%5, max. %10
SENSOR TYPE	-	POLYAMIDE RIBBON
ELECTRICAL CONNECTIONS	-	3-POLE TERMINAL
ELECTRICAL SECTION WIRES	-	FROM 0,75mm ² to 4.0mm ²
OPERATING TEMPERATURE	°C	+10 / +60
STORAGE TEMPERATURE	°C	+10 / +60
PROTECTION DEGREE	-	IP20
COLOUR	-	RAL7035
MOUNTING	-	CLIP FOR MOUNTING on DIN RAIL 35mm
DIMENSIONS HxWxD	mm	94x56x54
WEIGHT	g	180
CONFORMITY	-	CE

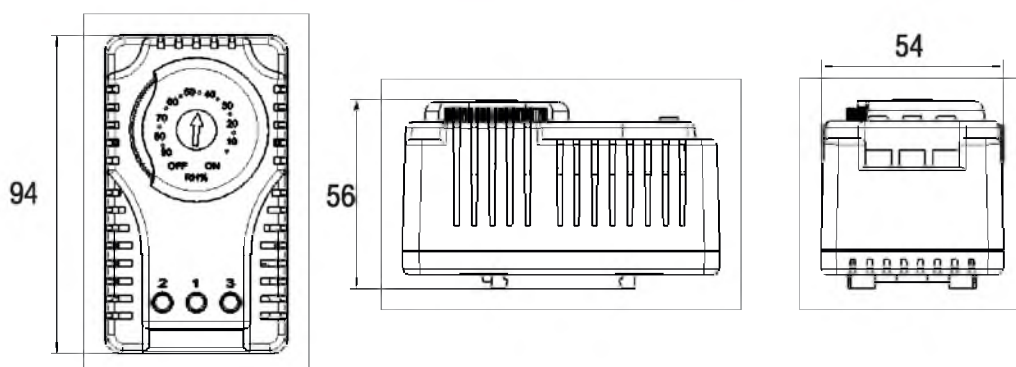

DIGITAL HYGROTHERM

Technical Specifications

- Dimensions : 35x77mm
- Display : 3 Digits 7 Segment
- Sensor Type : Digital Temperature/Humidity sensor
- Measuring Scale : -19.9 .. 80.0 °C, 5 .. 95%RH
- Resolution : ±1 °C, ±1%RH
- Accuracy (typical) : ± %1 (°C), ± % 3 (%RH); over full scale
- Control Form : ON-OFF
- °C Out Output : Relay (NO + NC), 250VAC, 2A, Resistive load
- %RH Out Output : Relay (NO), 250VAC, 2A, Resistive load
- °C Function : Ht (heating), CL (cooling);selectable
- %RH Function : lo (decrease humidity), hi (increase humidity);selectable
- Supply Voltage : 100..240VAC, 50 / 60Hz
- Power Consumption : < 6VA
- Operating Temp. : 0 .. 50 °C
- Operating Altitude : H-C; Ht(Heating), CL (Cooling); selectable
- Power Consumption : <6 VA
- Failure : In case of measurement failure, "Err" message displayed and Relay outputs become OFF.

NOTE: The temperature and humidity sensor is included in the device



HT-310

DIGITAL THERMOSTAT

Technical Specifications

- Dimensions : 36x90x65mm, rail mount
- Display : 3 Digits 7 Segment
- Sensor Type : PTC
- Measuring Scale : -50...+150 °C
- Resolution : ±1 °C
- Accuracy : ± %1 (Over full scale)
- Control Form : ON-OFF
- Out Output : Relay , 250 VAC, 2A, Resistive Load
- Alarm Output : Relay , 250 VAC, 2A, Resistive Load
- Heat Set : LoL...UPL °C (Hst)
- Alarm Set : AtP=Ab s,-Ab; LoL... °C (Ast)
AtP=rEL, -rL; (HSt+rAL) ,(HSt-20) ... (Hst+20) °C
- Heat Hysteresis : 1...20 °C (Hhs)
- Alarm Hysteresis : 1...20 °C (Hhs)
- Offset : -20...+20 °C (OFS)
- Function : H-C; Ht(Heating), CL (Cooling); selectable
- Supply Voltage : 100...240 VAC, 50/60 Hz
- Power Consumption : <6 VA
- Operating Temperature: -20 °C...55°C
- Operating Altitude : <2000m
Failure

NOTE: The PTC Sensor is included in the device.



PDT 50- 150

AIR CONDITIONING





STANDART

INOX

IP65

PANELTYPE AIR CONDITIONERS

MODELS	UNIT	PAC040.01	PAC050.01	PAC075.01	PAC100.01	PAC150.01	PAC200.01	PAC250.01	PAC350.01
COOLING CAPACITY	EN814 A35A35	400W	500W	750W	1000W	1500W	2000W	2500W	3500W
COOLING CAPACITY	EN814 A35A50	320W	400W	600W	800W	1200W	1600W	2000W	2800W
POWER SUPPLY	V / Hz	1 PHASE 230V 50/60 Hz							
DIMENSIONS HxWxD	mm	500x200x240	500x310x205	610x320x210	640x320x210	800x400x255	1000x255x400	1000x255x400	1200x255x400
MAX. CURRENT	A	2.65/2.75	2.65/2.75	2.65/2.75	3.50/3.60	4.50/4.60	6.00	6.00	6.00
DELAYED FUSE	A	6	6	6	10	10	16	16	16
REFRIGERANT	-	R134a							
OPERATING TEMPERATURE	C	+20 / +55							
TEMPERATURE CONTROLLER	-	DIGITAL THERMOSTAT FACTORY, SET 35 C							
COMPRESSOR TYPE	-	HERMETIC							
NOISE LEVEL	dB(A)	52	52	56	62	65	70	70	70
ELECTRICAL CONNECTIONS	-	3-POLE TERMINAL CONNECTOR							
PROTECTION DEGREE	-	ENCLOSURE INSIDE IP54, AMBIENT INSIDE IP34							
WEIGHT	kg	14.00	18.00	26.30	28.50	32.00	43.50	44.00	46.00
COLOUR	-	RAL7035 GREY (INOX & IP65 on request)							
CONFORMITY	-	CE							

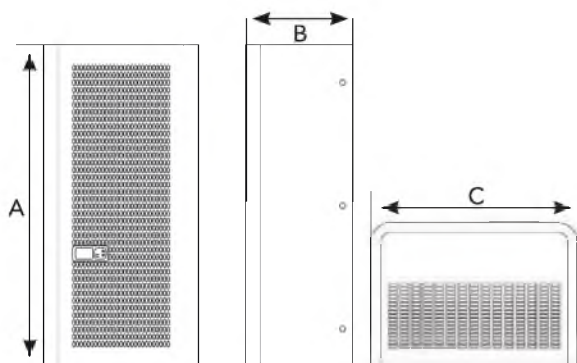

	A(mm)	B(mm)	C(mm)	WEIGHT(kg)
PAC040	500	200	240	14.00
PAC050	500	205	310	18.00
PAC075	610	210	320	26.30
PAC100	640	210	320	28.50
PAC150	800	255	400	32.00
PAC200	1000	255	400	43.50
PAC250	1000	255	400	44.00
PAC350	1200	255	400	46.00

THERMOELECTRIC COOLERS

CODE	COOLING CAPACITY	POWER SUPPLY	DIMENSIONS(mm) (WxLxH)	CUT MEASURE (mm)	WEIGHT (kg)
PTE 040-24	40W	24V DC	130x120x120	85x85	1.20
PTE 070-24	70W	24V DC	230x125x145	185x105	2.52
PTE 100-24	100W	24V DC	300x150x150	235x130	4.12
PTE 150-24	150W	24V DC	400x180x185	360x225	7.70
PTE 200-24	200W	24V DC	400x180x185	360x225	7.70



APPLICATION AREAS;

- ELECTRICAL PANELS
- RACK CABINETS
- VENDING MACHINES
- ATMs
- Base Stations
- Less costly application for any kind of small machinery plants
- Maintenance Free as it does not consist of any gas or compressor



PANEL ACCESSORIES

CODE	DESCRIPTION	PACK IN PCS
PFM 1000	FILTER MAT FOR PFI 1000	10
PFM 1500	FILTER MAT FOR PFI 1500	10
PFM 2500	FILTER MAT FOR PFI 2500	10
PFM 3000	FILTER MAT FOR PFI 3000	10



CODE	DESCRIPTION	PACK IN PCS
PT 0808	METALLIC PROTECTION GRILL FOR 80x80mm	100
PT 1212	METALLIC PROTECTION GRILL FOR 120x120mm	100
PT 1717	METALLIC PROTECTION GRILL FOR 170x170mm	100
PT 2020	METALLIC PROTECTION GRILL FOR 225x225mm	100
PT 2525	METALLIC PROTECTION GRILL FOR 280x280mm	100



PPCA4



PPCA5



PPA05

CODE	DESCRIPTION	PACK IN PCS
PPCA5	DRAWING POCKET A5 SIZE	10
PPCA4	DRAWING POCKET A4 SIZE	10
PPA05	KEY LOCK FOR ABS PANELS	10

HEATING





MINI PTC HEATERS

FEATURES	UNIT	MPHT 15	MPHT 25
HEATING CAPACITY	W	15	25
POWER SUPPLY	V	100-250V AC DC	
MAX. CURRENT	A	2A	
HEATING ELEMENT TYPE	-	PTC RESISTOR, SELF REGULATING	
OVERCURRENT PROTECTION	-	ELECTRONIC THERMAL OVERLOAD	
ELECTRICAL CONNECTIONS	-	LEAD WIRE 30cm L-N-E	
PROTECTION CLASS IEC	-	CLASS II	
PROTECTION DEGREE EN60529	-	IP20	
OPERATING TEMPERATURE	°C	-45 / +70	
STORAGE TEMPERATURE	°C	-45 / +70	
RADIATOR	-	ALLUMINIUM PROFILE, ANODIZED	
MOUNTING	-	CLIP FOR MOUNTING on DIN RAIL 35mm	
INSTALLATION POSITION	-	BEST EFFICIENCY IN VERTICAL POSITION	
DIMENSIONS HxWxD	mm	60x50x27	70x50x27
WEIGHT	kg	0.11	0.12
CONFORMITY	-	CE	

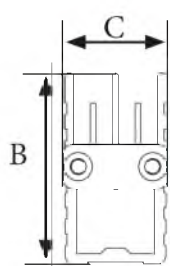
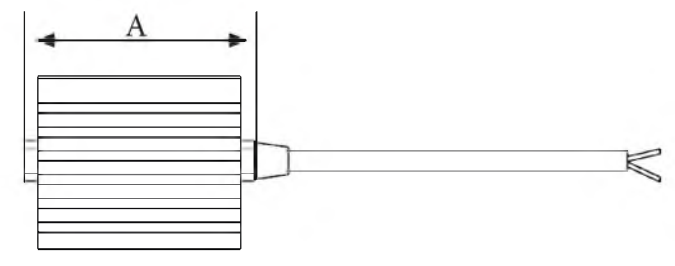

	A	B	C
MPHT15	60	50	27
MPHT25	70	50	27



PTC HEATERS

FEATURES	UNIT	PHT 030	PHT 050	PHT 075	PHT 100	PHT 150
HEATING CAPACITY	W	30	50	75	100	150
POWER SUPPLY	V	100-250V AC DC				
MAX. CURRENT	A	2A	2A	4A	4A	6A
HEATING ELEMENT TYPE	-	PTC RESISTOR, SELF REGULATING				
OVERCURRENT PROTECTION	-	ELECTRONIC THERMAL OVERLOAD				
ELECTRICAL CONNECTIONS	-	3 POLE TERMINAL N-L-E				
PROTECTION CLASS IEC	-	CLASS II				
PROTECTION DEGREE EN60529	-	IP20				
OPERATING TEMPERATURE	°C	-45 / +70				
STORAGE TEMPERATURE	°C	-45 / +70				
RADIATOR	-	ALLUMINIUM PROFILE, ANODIZED				
MOUNTING	-	CLIP FOR MOUNTING on DIN RAIL 35mm				
INSTALLATION POSITION	-	BEST EFFICIENCY IN VERTICAL POSITION				
DIMENSIONS HxWxD	mm	128x70x59	138x70x59	178x70x59	188x70x59	228x70x59
WEIGHT	kg	0.41	0.44	0.54	0.59	0.72
CONFORMITY	-	CE				

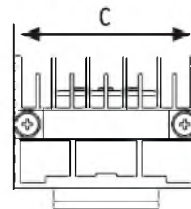
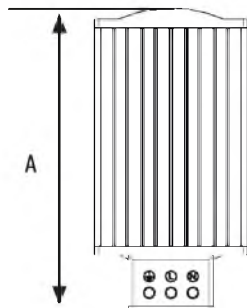

	A	B	C
PHT030	128	59	70
PHT050	138	59	70
PHT075	178	59	70
PHT100	188	59	70
PHT150	228	59	70



PTC HEATERS WITH FAN

FEATURES	UNIT	PFHT 100	PFHT 150
HEATING CAPACITY	W	100	150
POWER SUPPLY	V	230V AC 50/60 Hz	
MAX. CURRENT	A	4A	4A
HEATING ELEMENT TYPE	-	PTC RESISTOR, SELF REGULATING	
AXIAL FAN	-	60x60x30mm 16m ³ /h	
OVERCURRENT PROTECTION	-	ELECTRONIC THERMAL OVERLOAD	
ELECTRICAL CONNECTIONS	-	3-POLE TERMINAL N-L-E	
PROTECTION CLASS IEC	-	CLASS II	
PROTECTION DEGREE EN60529	-	IP20	
OPERATING TEMPERATURE	°C	-45 / +70	
STORAGE TEMPERATURE	°C	-45 / +70	
RADIATOR	-	ALLUMINIUM PROFILE, ANODIZED	
MOUNTING	-	CLIP FOR MOUNTING on DIN RAIL 35mm	
INSTALLATION POSITION	-	BEST EFFICIENCY IN VERTICAL POSITION	
DIMENSIONS HxWxD	mm	170x89x60	210x89x60
WEIGHT	kg	0.70	0.94
CONFORMITY	-	CE	

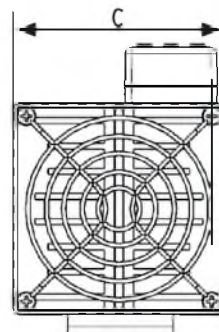
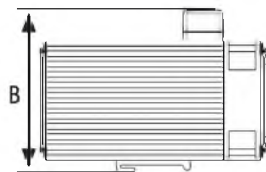
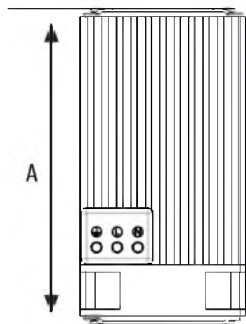

	A	B	C
FPHT100	170	89	60
FPHT150	210	89	60



RESISTANCE HEATERS WITH FAN

FEATURES	UNIT	PFHT 250	PFHT 500	PFHT 750
HEATING CAPACITY	W	250	500	750
POWER SUPPLY	V	230V 50/60Hz		
MAX. CURRENT	A	1.2A	2.4A	3.6A
HEATING ELEMENT TYPE	-	RESISTANCE HEATER		
AXIAL FAN	-	80x80x25mm 35m ³ /h		
OVERCURRENT PROTECTION	-	ELECTRONIC THERMAL OVERLOAD		
ELECTRICAL CONNECTIONS	-	3-POLE TERMINAL N-L-E		
PROTECTION CLASS IEC	-	CLASS I, EARTHED		
PROTECTION DEGREE EN60529	-	IP20		
OPERATING TEMPERATURE	°C	-25 / +70		
STORAGE TEMPERATURE	°C	-25 / +70		
RADIATOR	-	ALLUMINIUM PROFILE, ANODIZED		
MOUNTING	-	CLIP FOR MOUNTING on DIN RAIL 35mm		
INSTALLATION POSITION	-	BEST EFFICIENCY IN VERTICAL POSITION		
DIMENSIONS HxWxD	mm	152x80x110	182x80x110	232x80x110
WEIGHT	kg	0.98	1.20	1.45
CONFORMITY	-	CE		

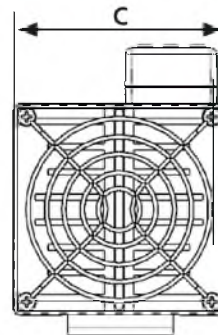
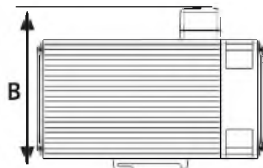
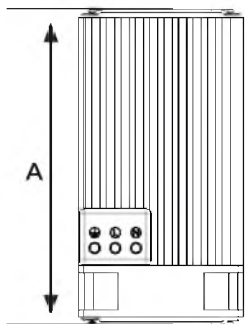

	A	B	C
PFHT250	152	110	80
PFHT500	182	110	80
PFHT750	232	110	80



PTC SLIM HEATERS

FEATURES	UNIT	PSHT 030	PSHT 050	PSHT 075	PSHT 100	PSHT 150
HEATING CAPACITY	W	30	50	75	100	150
POWER SUPPLY	V	100-250V AC DC				
MAX. CURRENT	A	2A	2A	4A	4A	6A
HEATING ELEMENT TYPE	-	PTC RESISTOR, SELF REGULATING				
OVERCURRENT PROTECTION	-	ELECTRONIC THERMAL OVERLOAD				
ELECTRICAL CONNECTIONS	-	3 POLE TERMINAL N-L-E				
PROTECTION CLASS IEC	-	CLASS II				
PROTECTION DEGREE EN60529	-	IP20				
OPERATING TEMPERATURE	°C	-45 / +70				
STORAGE TEMPERATURE	°C	-45 / +70				
RADIATOR	-	ALLUMINIUM PROFILE, ANODIZED				
MOUNTING	-	CLIP FOR MOUNTING on DIN RAIL 35mm				
INSTALLATION POSITION	-	BEST EFFICIENCY IN VERTICAL POSITION				
DIMENSIONS HxWxD	mm	148x80x27	148x80x27	166x80x27	166x80x27	229x80x27
WEIGHT	kg	190	190	225	235	325
CONFORMITY	-	CE				

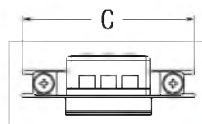
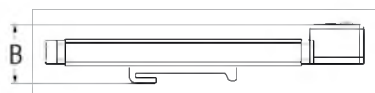
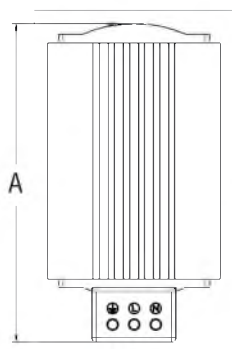

CODE	A (mm)	B (mm)	C (mm)
PSHT 030	148	27	80
PSHT 050	148	27	80
PSHT 075	166	27	80
PSHT 100	166	27	80
PSHT 150	229	27	80







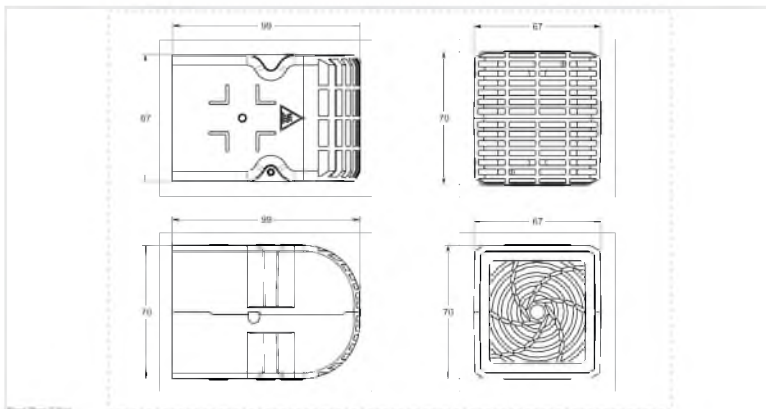

PTC FAN HEATERS

FEATURES	UNIT	PFHT 400
HEATING CAPACITY	W	200 / 300 / 400 According to connection
POWER SUPPLY	V	115-230V AC 50/60 Hz
MAX. CURRENT	A	-
HEATING ELEMENT TYPE	-	PTC RESISTOR, SELF REGULATING
ELECTRICAL CONNECTIONS	-	LEAD WIRE 30cm L-N*E
PROTECTION CLASS IEC	-	CLASS II
PROTECTION DEGREE EN60529	-	IP20
OPERATING TEMPERATURE	°C	-45 / +70
STORAGE TEMPERATURE	°C	-45 / +70
RADIATOR	-	PPS + Fiberglass work up to 280°C
MOUNTING	-	CLIP FOR MOUNTING on DIN RAIL 35mm
INSTALLATION POSITION	-	BEST EFFICIENCY IN VERTICAL POSITION
DIMENSIONS HxWxD	mm	99x70x67
WEIGHT	kg	0.25
CONFORMITY	-	CE







CODE	A (mm)	B (mm)	C (mm)
PFHT 400	99	70	67

DISTRIBUTION BLOCKS

	CODE PDB 207	CABLE TYPE	CABLE SECTION mm2	
			INPUT	OUTPUT
	NUMBER OF POLES (2)	Single Core	1x10-35 mm ²	1x10-25 mm ² 5x2,5-6 mm ²
CURRENT 125 Amper	Multi Core	1x10-16 mm ²	1x6-16 mm ² 5x1,5-6 mm ²	
	CODE PDB 211	CABLE TYPE	CABLE SECTION mm2	
			INPUT	OUTPUT
	NUMBER OF POLES (2)	Single Core	2x10-35 mm ²	2x10-25 mm ² 7x2,5-6 mm ²
CURRENT 125 Amper	Multi Core	2x10-16 mm ²	2x6-16 mm ² 7x1,5-6 mm ²	
	CODE PDB 215	CABLE TYPE	CABLE SECTION mm2	
			INPUT	OUTPUT
	NUMBER OF POLES (2)	Single Core	2x10-35 mm ²	2x10-25 mm ² 11x2,5-6 mm ²
CURRENT 125 Amper	Multi Core	2x10-16 mm ²	2x6-16 mm ² 11x1,5-6 mm ²	
	CODE PDB 407	CABLE TYPE	CABLE SECTION mm2	
			INPUT	OUTPUT
	NUMBER OF POLES (4)	Single Core	1x10-35 mm ²	1x10-25 mm ² 5x2,5-6 mm ²
CURRENT 125 Amper	Multi Core	1x10-16 mm ²	1x6-16 mm ² 5x1,5-6 mm ²	
	CODE PDB 411	CABLE TYPE	CABLE SECTION mm2	
			INPUT	OUTPUT
	NUMBER OF POLES (4)	Single Core	2x10-35 mm ²	2x10-25 mm ² 7x2,5-6 mm ²
CURRENT 125 Amper	Multi Core	2x10-16 mm ²	2x6-16 mm ² 7x1,5-6 mm ²	
	CODE PDB 415	CABLE TYPE	CABLE SECTION mm2	
			INPUT	OUTPUT
	NUMBER OF POLES (4)	Single Core	2x10-35 mm ²	2x10-25 mm ² 11x2,5-6 mm ²
CURRENT 125 Amper	Multi Core	2x10-16 mm ²	2x6-16 mm ² 11x1,5-6 mm ²	
	CODE PDB 4160	CABLE TYPE	FOUR POLE 160 Amper	
	NUMBER OF POLES (4)			
	CURRENT 160 Amper			

DISTRIBUTION BLOCKS

	CODE PDB 80	CABLE SECTION mm²	
		INPUT	OUT
	CURRENT 80 Amper	1x6-16 mm ²	4x2,5-6 mm ² 2x2,5-16 mm ²
	CODE PDB 125	CABLE SECTION mm²	
		INPUT	OUT
	CURRENT 125 Amper	1x10-35 mm ²	6x2,5-16 mm ² Bridge 1x6-16 mm ²
	CODE PDB 160	CABLE SECTION mm²	
		INPUT	OUT
	CURRENT 160 Amper	1x10-70 mm ²	6x2,5-16 mm ² Bridge 1x6-16 mm ²
	CODE PDB 250	CABLE SECTION mm²	
		INPUT	OUT
	CURRENT 250 Amper	1x35-120 mm ²	4x2,5-10 mm ² 5x2,5-16 mm ² 2x6-35 mm ²
	CODE PDB 400	CABLE SECTION mm²	
		INPUT	OUT
	CURRENT 400 Amper	1x95-185 mm ²	4x2,5-10 mm ² 5x2,5-16 mm ² 2x6-35 mm ²
	CODE PDB 500	CABLE SECTION mm²	
		INPUT	OUT
	CURRENT 500 Amper	Bara 8x24 mm ²	4x2,5-10 mm ² 5x2,5-16 mm ² 2x6-35 mm ²
	CODE PDB 4200	FOUR POLE 200 Amper	
	NUMBER OF POLES (4)		
	CURRENT 200 Amper		

COPPER TUBULAR CABLE LUGS



CODE	CROSS SECTION	BOLT Ø	D4	WALL THICKNESS	A	D1	B	C1	C2	L	PACKAGE QTY
SKP10-5	10 mm	M5	6,2	0,75	13,3	4,7	10,5	7,2	8,8	29,8	800
SKP16-6	16 mm	M6	7,9	0,75	18,5	6,4	11,8	7,1	7,5	33,5	500
SKP25-8	25 mm	M8	9,0	0,85	22,1	7,3	13,2	7,8	9,0	38,6	300
SKP35-8	35 mm	M8	10,8	1,15	25,5	8,5	15,5	9,3	9,6	44,5	200
SKP35-10	35 mm	M10	10,8	1,15	25,5	8,5	15,5	9,3	9,6	44,5	200
SKP50-10	50 mm	M10	12,6	1,30	28,6	10,0	18,2	10,8	12,1	51,5	150
SKP70-10	70 mm	M10	14,5	1,50	34,5	11,5	21,0	10,8	10,0	55,0	100
SKP95-10	95 mm	M10	16,5	1,50	37,0	13,5	24,2	10,85	12,0	60,0	80
SKP95-12	95 mm	M12	16,5	1,50	37,0	13,5	24,2	10,85	12,0	60,0	80
SKP120-12	120 mm	M12	19,1	1,80	43,0	15,5	28,0	13,9	13,2	70,0	50
SKP150-12	150 mm	M12	20,6	1,80	43,2	17,0	30,2	16,3	16,0	75,5	30
SKP185-16	185 mm	M16	22,6	1,90	47,3	18,8	33,5	17,0	18,6	83,0	30
SKP240-16	240 mm	M16	25,2	2,00	54,7	21,2	37,5	17,35	18,2	90,0	25

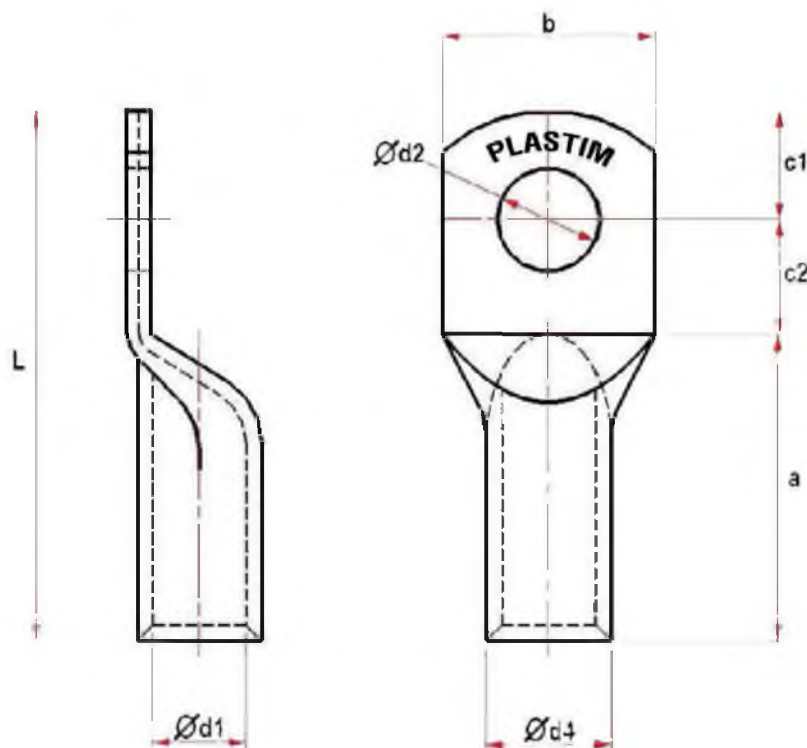

DIN RAILS AND SUPPORT



PRODUCT CODE	DESCRIPTION	TYPE	LENGTH	PACKING QTY
PDR1001	35x7.5mm	Un Perforated	1mt	20
PDR1002	35x7.5mm	Un Perforated	2mt	20
PDR2001	35x7.5mm	Perforated	1mt	20
PDR2002	35x7.5mm	Perforated	2mt	20

PRODUCT CODE	DESCRIPTION	TYPE	LENGTH	PACKING QTY
PDR3001	35x15mm	Un Perforated	1mt	10
PDR3002	35x15mm	Un Perforated	2mt	10
PDR4001	35x15mm	Perforated	1mt	10
PDR4002	35x15mm	Perforated	2mt	10



PRODUCT CODE	DESCRIPTION	PACKING / QTY
PRT	DIN Rail Support	25 Pcs

PET EXPANDABLE BRAIDED SLEEVING

New
Products





- Halogen free
- VW-1 Flame Retardant
- -60...+150C
- RoHS



CODE	DESCRIPTION	SPOOL LENGHT
PKC-03	PET Expandable Braided Sleeving 3 mm Black	100m
PKC-06	PET Expandable Braided Sleeving 6 mm Black	100m
PKC-08	PET Expandable Braided Sleeving 8 mm Black	100m
PKC-10	PET Expandable Braided Sleeving 10 mm Black	100m
PKC-12	PET Expandable Braided Sleeving 12 mm Black	100m
PKC-15	PET Expandable Braided Sleeving 15 mm Black	100m
PKC-20	PET Expandable Braided Sleeving 20 mm Black	50m
PKC-25	PET Expandable Braided Sleeving 25 mm Black	50m
PKC-30	PET Expandable Braided Sleeving 30 mm Black	50m
PKC-40	PET Expandable Braided Sleeving 40 mm Black	50m
PKC-50	PET Expandable Braided Sleeving 50 mm Black	25m











CABLE TERMINALS

Insulated Cord End Terminals German Norm

Product Code	Color	Cross Section	Dimensions					Package Qty
			[F]	[L]	[W]	[B]	[D]	
PKY-2005		0,50	8	14	2,6	6,0	1,3	1000
PKY-2007		0,75	8	14	2,8	6,3	1,5	1000
PKY-2010		1,00	8	14	3,0	6,3	1,7	1000
PKY-2015		1,50	8	14	3,5	6,3	2,0	1000
PKY-2025		2,50	8	14	4,2	7,4	2,5	500
PKY-2040		4,00	10	17	4,8	7,4	3,2	500
PKY-2060		6,00	12	20	6,3	8,5	3,9	250
PKY-2100		10,00	12	22	7,6	8,8	4,9	100
PKY-2160		16,00	12	24	8,8	10,0	6,2	100
PKY-2250		25,00	16	28	11,2	12,0	7,7	50
PKY-2350		35,00	16	30	12,7	14,0	8,7	50
PKY-2500		50,00	20	36	15,0	16,0	10,9	25











Insulated Cord End Terminals French Norm

Product Code	Color	Cross Section	Dimensions					Package Qty
			[F]	[L]	[W]	[B]	[D]	
PKY-3005		0,50	8	14	2,6	6,0	1,3	1000
PKY-3007		0,75	8	14	2,8	6,3	1,5	1000
PKY-3010		1,00	8	14	3,0	6,3	1,7	1000
PKY-3015		1,50	8	14	3,5	6,3	2,0	1000
PKY-3025		2,50	8	14	4,2	7,4	2,5	500
PKY-3040		4,00	10	17	4,8	7,4	3,2	500
PKY-3060		6,00	12	20	6,3	8,5	3,9	250
PKY-3100		10,00	12	22	7,6	8,8	4,9	100
PKY-3160		16,00	12	24	8,8	10,0	6,2	100
PKY-3250		25,00	16	28	11,2	12,0	7,7	50
PKY-3350		35,00	16	30	12,7	14,0	8,7	50
PKY-3500		50,00	20	36	15,0	16,0	10,9	25











CABLE TERMINALS

Insulated Twin Cord End Terminals German Norm

Product Code	Color	Cross Section	Dimensions					Package Qty
			[F]	[L]	[W]	[B]	[D]	
PKY-22005		2x0,50	8	14	5,0	6,5	1,8	1000
PKY-22007		2x0,75	8	14	5,5	6,7	2,1	500
PKY-22010		2x1,00	8	14	5,5	7,1	2,4	500
PKY-22015		2x1,50	8	14	6,4	7,5	2,6	500
PKY-22025		2x2,50	10	14	8,0	8,5	3,3	250
PKY-22040		2x4,00	12	17	8,0	11,1	4,2	200
PKY-22060		2x6,00	14	20	9,5	12,1	5,3	100
PKY-22100		2x10,00	14	27	12,6	12,6	6,9	50
PKY-22160		2x16,00	14	31	19,0	19,0	8,7	25



Insulated Twin Cord End Terminals French Norm

Product Code	Color	Cross Section	Dimensions					Package Qty
			[F]	[L]	[W]	[B]	[D]	
PKY-23005		2x0,50	8	14	5,0	6,5	1,8	1000
PKY-23007		2x0,75	8	14	5,5	6,7	2,1	500
PKY-23010		2x1,00	8	14	5,5	7,1	2,4	500
PKY-23015		2x1,50	8	14	6,4	7,5	2,6	500
PKY-23025		2x2,50	10	14	8,0	8,5	3,3	250
PKY-23040		2x4,00	12	17	8,0	11,1	4,2	200
PKY-23060		2x6,00	14	20	9,5	12,1	5,3	100
PKY-23100		2x10,00	14	27	12,6	12,6	6,9	50
PKY-23160		2x16,00	14	31	19,0	19,0	8,7	25



Ring Type Insulated Cable Terminals

Product Code	Cross Section	Bolt Size	Dimensions (mm)				Package Qty
			[D2]	[I]	[D4]	[A]	
PYK-301	0,50-1,50mm	M3	3,2	16,0	4,0	10,0	200
PYK-401	0,50-1,50mm	M4	4,3	17,0	4,0	10,0	200
PYK-501	0,50-1,50mm	M5	5,3	18,0	4,0	10,0	200
PYK-601	0,50-1,50mm	M6	6,5	18,0	4,0	10,0	200
PYK-801	0,50-1,50mm	M8	8,4	22,0	4,0	10,0	200



Product Code	Cross Section	Bolt Size	Dimensions (mm)				Package Qty
			[D2]	[I]	[D4]	[A]	
PYK-302	1,50-2,50mm	M3	3,2	16,0	4,5	10,0	200
PYK-402	1,50-2,50mm	M4	4,3	17,0	4,5	10,0	200
PYK-502	1,50-2,50mm	M5	5,3	19,0	4,5	10,0	200
PYK-602	1,50-2,50mm	M6	6,5	21,0	4,5	10,0	200
PYK-802	1,50-2,50mm	M8	8,4	22,0	4,5	10,0	200
PYK-1002	1,50-2,50mm	M10	10,5	22,0	4,5	10,0	200

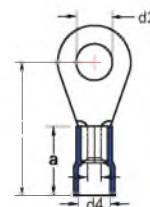

Product Code	Cross Section	Bolt Size	Dimensions (mm)				Package Qty
			[D2]	[I]	[D4]	[A]	
PYK-406	4,00-6,00mm	M4	4,3	21,0	6,3	13,0	100
PYK-506	4,00-6,00mm	M5	5,3	22,0	6,3	13,0	100
PYK-606	4,00-6,00mm	M6	6,5	22,5	6,3	13,0	100
PYK-806	4,00-6,00mm	M8	8,4	26,0	6,3	13,0	100
PYK-1006	4,00-6,00mm	M10	10,5	28,0	6,3	13,0	100
PYK-1206	4,00-6,00mm	M12	13,0	28,0	6,3	13,0	100

CABLE TERMINALS

Fork Type - Insulated Cable Terminals

Product Code	Cross Section	Bolt Size	Dimensions (mm)				Package Qty
			[D2]	[I]	[D4]	[A]	
PCK-301	0,50-1,50mm	M3	3,2	16,0	4,0	10,0	200
PCK-401	0,50-1,50mm	M4	4,3	17,0	4,0	10,0	200
PCK-501	0,50-1,50mm	M5	5,3	18,0	4,0	10,0	200
PCK-601	0,50-1,50mm	M6	6,5	20,0	4,0	10,0	200



Product Code	Cross Section	Bolt Size	Dimensions (mm)				Package Qty
			[D2]	[I]	[D4]	[A]	
PCK-302	1,50-2,50mm	M3	3,2	18,0	4,5	10,0	200
PCK-402	1,50-2,50mm	M4	4,3	17,0	4,5	10,0	200
PCK-502	1,50-2,50mm	M5	5,3	19,0	4,5	10,0	200
PCK-602	1,50-2,50mm	M6	6,5	21,0	4,5	10,0	200

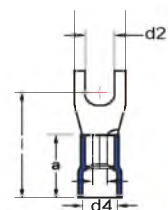

Product Code	Cross Section	Bolt Size	Dimensions (mm)				Package Qty
			[D2]	[I]	[D4]	[A]	
PCK-406	4,00-6,00mm	M4	8,4	22,0	4,5	10,0	100
PCK-506	4,00-6,00mm	M5	10,5	22,0	4,5	10,0	100
PCK-606	4,00-6,00mm	M6	13,0	25,0	4,5	10,0	100
PCK-806	4,00-6,00mm	M8	4,0	21,0	6,3	13,0	100



CABLE TERMINALS

Insulated Female Terminals

Product Code	Cross Section	Dimensions (mm)					Package Qty
		[W]	[F]	[L]	[E]	[D]	
PFT-1040	0,50-1,50mm	3,9	7,0	23,3	10,5	3,8	200
PFT-2050	1,50-2,50mm	4,9	7,0	23,3	10,5	4,7	100
PFT-5050	4,00-6,00mm	4,9	7,0	25,1	12,5	6,2	100

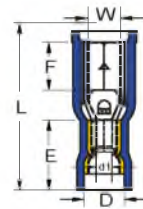

Insulated Male Terminals

Product Code	Cross Section	Dimensions (mm)					Package Qty
		[W]	[F]	[L]	[E]	[D]	
PMT-1040	0,50-1,50mm	4,0	8,5	21,5	10,5	3,8	200
PMT-2050	1,50-2,50mm	5,0	8,5	21,2	10,5	4,7	100
PMT-5050	4,00-6,00mm	5,0	8,5	24,0	13,0	6,2	100

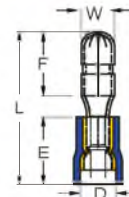

Insulated Pin Type Terminals

Product Code	Cross Section	Dimensions (mm)					Package Qty
		[W]	[F]	[L]	[E]	[D]	
PKI-101	0,50-1,50mm	1,9	10,0	19,0	10,0	4,0	200
PKI-102	1,50-2,50mm	1,9	12,0	21,8	10,0	4,5	200
PKI-106	4,00-6,00mm	2,8	14,0	27,0	27,0	6,4	100

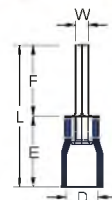

CABLE TERMINALS

Insulated Female Disconnectors

Product Code	Cross Section	Socket Width	Dimensions (mm)					Package Qty
			[W]	[F]	[L]	[E]	[D]	
PFD-1288	0,50-1,50mm	0,8x2,80	3,2	6,5	19,0	10,5	3,8	200
PFD-1488	0,50-1,50mm	0,8x4,75	5	6,4	19,4	10,5	3,8	200
PFD-1638	0,50-1,50mm	0,8x6,35	6,6	7,5	20,8	10,5	3,8	200
PFD-2488	1,50-2,50mm	0,8x4,75	5	6,4	19,4	10,5	4,7	200
PFD-2638	1,50-2,50mm	0,8x6,35	6,6	7,5	20,8	10,5	4,7	200
PFD-5638	4,00-6,00mm	0,8x6,35	6,6	7,5	23,3	13,0	6,2	100

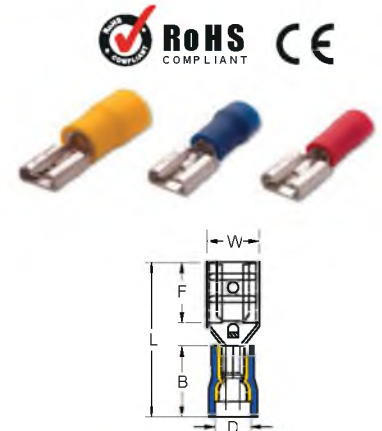

Fully Insulated Female Disconnectors

Product Code	Cross Section	Socket Width	Dimensions (mm)					Package Qty
			[W]	[F]	[L]	[E]	[D]	
IPFD-1288	0,50-1,50mm	0,8x2,80	3,2	6,5	19,0	10,5	3,8	200
IPFD-1488	0,50-1,50mm	0,8x4,75	5	6,4	19,4	10,5	3,8	200
IPFD-1638	0,50-1,50mm	0,8x6,35	6,6	7,5	20,8	10,5	3,8	200
IPFD-2488	1,50-2,50mm	0,8x4,75	5	6,4	19,4	10,5	4,7	200
IPFD-2638	1,50-2,50mm	0,8x6,35	6,6	7,5	20,8	10,5	4,7	200
IPFD-5638	4,00-6,00mm	0,8x6,35	6,6	7,5	23,3	13,0	6,2	100



Insulated Male Disconnectors

Product Code	Cross Section	Socket Width	Dimensions (mm)					Package Qty
			[W]	[F]	[L]	[E]	[D]	
PFE-1288	0,50-1,50mm	0,8x2,80	2,8	6,5	19,2	10,5	3,8	200
PFE-1488	0,50-1,50mm	0,8x4,75	4,8	6,7	19,8	10,5	3,8	200
PFE-1638	0,50-1,50mm	0,8x6,35	6,35	7,7	21,8	10,5	3,8	200
PFE-2488	1,50-2,50mm	0,8x4,75	4,8	6,7	19,8	10,5	4,7	200
PFE-2638	1,50-2,50mm	0,8x6,35	6,35	7,7	21,8	10,5	4,7	200
PFE-5638	4,00-6,00mm	0,8x6,35	6,35	7,7	24,0	13,0	6,2	100

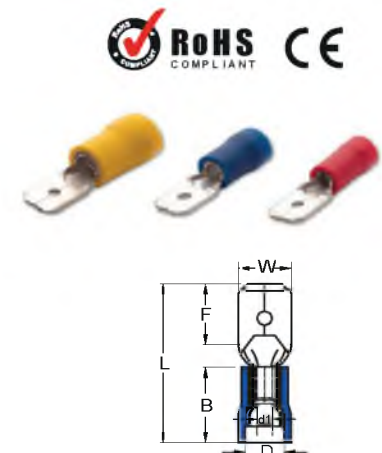

















PBO PUSH BUTTON SERIES

















PBO PUSH BUTTON SERIES

Q22mm

	PRODUCT CODE	HEAD COLOR	DESCRIPTION	CONTACT	PACKAGE QTY
	PB0-AA31	 Green	Push Button Green	1NO	10
	PB0-AA42	 Red	Push Button Red	1NC	10
	PB0-AA51	 Yellow	Push Button Yellow	1NO	10
	PB0-AA61	 Blue	Push Button Blue	1NO	10
	PB0-AA11	 White	Push Button White	1NO	10
	PB0-AA21	 Black	Push Button Black	1NO	10

	PB0-AW31B5	 White	LED Illuminated Push Button 24V White	1NO	10
	PB0-AW33B5	 Green	LED Illuminated Push Button 24V Green	1NO	10
	PB0-AW34B5	 Red	LED Illuminated Push Button 24V Red	1NC	10
	PB0-AW35B5	 Yellow	LED Illuminated Push Button 24V Yellow	1NO	10
	PB0-AW36B5	 Blue	LED Illuminated Push Button 24V Blue	1NO	10

	PB0-AW31M5	 White	LED Illuminated Push Button 220V White	1NO	10
	PB0-AW33M5	 Green	LED Illuminated Push Button 220V Green	1NO	10
	PB0-AW34M5	 Red	LED Illuminated Push Button 220V Red	1NC	10
	PB0-AW35M5	 Yellow	LED Illuminated Push Button 220V Yellow	1NO	10
	PB0-AW36M5	 Blue	LED Illuminated Push Button 220V Blue	1NO	10

	PB0-AC42	 Red	Mushroom Red Button	1NC	10
	PB0-AC31	 Green	Mushroom Green Button	1NO	10
	PB0-AS542	 Red	Emergency Stop Red	1NC	10
	PB0-AS542-24L	 Red	LED Emergency Stop 24V Red	1NC	10
	PB0-AS542-230L	 Red	LED Emergency Stop 220V Red	1NC	10

PBO PUSH BUTTON SERIES

Q22mm

	PRODUCT CODE	HEAD COLOR	DESCRIPTION	CONTACT	PACKAGE QTY
	PB0-AD21	Black	0-1 Selector	1NO	10
	PB0-AD33	Black	1-0-2 Selector	2NO	10
	PB0-AD53	Black	1-0-2 Selector Spring Turn	2NO	10
	PB0-AD41	Black	0-1 Selector Spring Turn	1NO	10
	PB0-AJ21	Black	0-1 Selector Long Handle	1NO	10
	PB0-AJ33	Black	1-0-2 Selector Long Handle	2NO	10
	PB0-AJ53	Black	1-0-2 Selector Spring Turn Long Handle	2NO	10

	PB0-AK123B5	Green	LED Illuminated Selector 0-1 Button 24V Green	1NO	10
	PB0-AK124B5	Red	LED Illuminated Selector 0-1 Button 24V Red	1NC	10
	PB0-AK125B5	Yellow	LED Illuminated Selector 0-1 Button 24V Yellow	1NO	10
	PB0-AK123M5	Green	LED Illuminated Selector 0-1 Button 220V Green	1NO	10
	PB0-AK124M5	Red	LED Illuminated Selector 0-1 Button 220V Red	1NC	10
	PB0-AK125M5	Yellow	LED Illuminated Selector 0-1 Button 220V Yellow	1NO	10

	PB0-AK133B5	Green	LED Illuminated Selector 1-0-2 Button 24V Green	2NO	10
	PB0-AK134B5	Red	LED Illuminated Selector 1-0-2 Button 24V Red	2NC	10
	PB0-AK135B5	Yellow	LED Illuminated Selector 1-0-2 Button 24V Yellow	2NO	10
	PB0-AK133M5	Green	LED Illuminated Selector 1-0-2 Button 220V Green	2NO	10
	PB0-AK134M5	Red	LED Illuminated Selector 1-0-2 Button 220V Red	2NC	10
	PB0-AK135M5	Yellow	LED Illuminated Selector 1-0-2 Button 220V Yellow	2NO	10

	PB0-AG21	Black	Selector Button With Keylock 0-1	1NO	10
	PB0-AG33	Black	Selector Button With Keylock 1-0-2	2NO	10

PBO PUSH BUTTON SERIES

Q22mm



PRODUCT CODE	HEAD COLOR	DESCRIPTION	CONTACT	PACKAGE QTY
PB0-AL73415	Red+Green	Twin Button	1NO+1NC	10
PB0-AW734B5	Red+Green	LED Twin Button 24V	1NO+1NC	10
PB0-AW734M5	Red+Green	LED Twin Button 220V	1NO+1NC	10



PB0-LS22-24R	Red	LED Pilot Light Q22mm 24V Red	- -	10
PB0-LS22-24G	Green	LED Pilot Light Q22mm 24V Green	- -	10
PB0-LS22-24Y	Yellow	LED Pilot Light Q22mm 24V Yellow	- -	10
PB0-LS22-24W	White	LED Pilot Light Q22mm 24V White	- -	10
PB0-LS22-24B	Blue	LED Pilot Light Q22mm 24V Blue	- -	10
PB0-LS22-220R	Red	LED Pilot Light Q22mm 220V Red	- -	10
PB0-LS22-220G	Green	LED Pilot Light Q22mm 220V Green	- -	10
PB0-LS22-220Y	Yellow	LED Pilot Light Q22mm 220V Yellow	- -	10
PB0-LS22-220W	White	LED Pilot Light Q22mm 220V White	- -	10
PB0-LS22-220B	Blue	LED Pilot Light Q22mm 220V Blue	- -	10



PB0-B22-24	Black	Buzzer 24VAC-DC Black	- -	10
PB0-B22-220	Black	Buzzer 220VAC-DC Black	- -	10
PB0-LB22-24R	Red	Flash Buzzer Q22mm 24V AC-DC Red	- -	10
PB0-LB22-220R	Red	Flash Buzzer Q22mm 220V AC-DC Red	- -	10



PB0-POT-1K	Black	Single Turn Potentiometer 1K Ohm (Ω)	- -	10
PB0-POT-2.5K	Black	Single Turn Potentiometer 2.5K Ohm (Ω)	- -	10
PB0-POT-5K	Black	Single Turn Potentiometer 5K Ohm (Ω)	- -	10
PB0-POT-10K	Black	Single Turn Potentiometer 10K Ohm (Ω)	- -	10

PBO PUSH BUTTON SERIES AND SIGNAL ACCESSORIES

Q22mm



CODE	COLOR	DESCRIPTION	CONTACT
PB-BK 01Y	Yellow-Black	1 Hole Push Button Box	- -
PB-BK 01G	Grey-Black	1 Hole Push Button Box	- -
PB-BK 02G	Grey-Black	2 Hole Push Button Box	- -
PB-BK 03G	Grey-Black	3 Hole Push Button Box	- -
PB-BK 04G	Grey-Black	4 Hole Push Button Box	- -
PB-BK 05G	Grey-Black	5 Hole Push Button Box	- -



PB0-KB01	NC Contact	NC Contact	1NC
PB0-KB10	NO Contact	NO Contact	1NO



PB0-A-M5		Button LED Contact 220VAC	- -
PB0-A-B5		Button LED Contact 24VAC-DC	- -

PB-SB22	Silicon Button Protection Top Q22 Transparent	- -
PB-BSA	Button Stud Clamping Tool	- -
PB-ES60	Emergency Stop Label Q60	- -
PB-ES90	Emergency Stop Label Q90	- -
PB-BR2515	Label for Q22 Button	- -
PB-KT22	Panel Plug Q22	- -
PB-BK0	Protection Cover Oval	- -
PB-BKY	Protection Cover Round	- -



PB-SB22



PB-BSA



PB-ES60

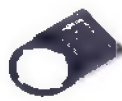

PB-BR2515



PB-KT22



PB-BK0



PB-BKY

CURRENT TRANSFORMER



NEW!

CURRENT TRANSFORMER

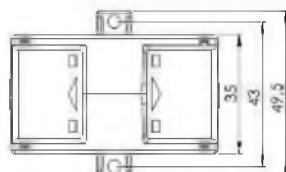
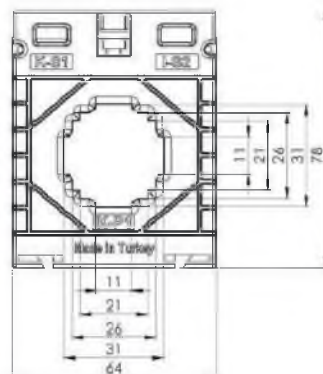
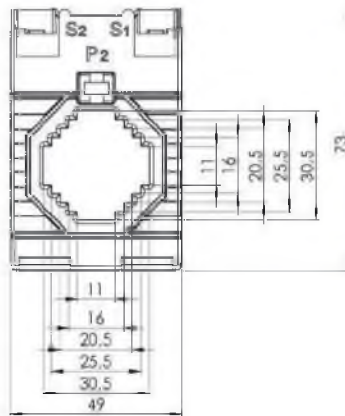
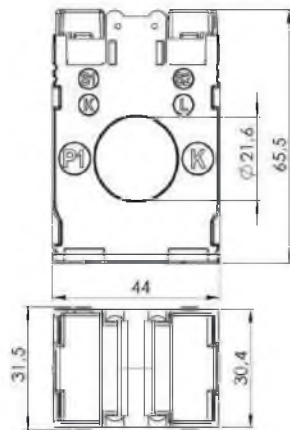

Description				Class		
Series	Code	Hole (mm)	Primary (A)	Class 0.5	Class 1.0	Class 3.0
PCK20	PCK20405	20	40	-	-	1.5 VA
	PCK25005	20	50	-	-	1.5 VA
	PCK20605	20	60	-	-	2.5 VA
	PCK20805	20	80	-	-	2.5 VA
	PCK201005	20	100	-	2.5 VA	-
	PCK201255	20	125	-	2.5 VA	-
	PCK201505	20	150	-	2.5 VA	-
	PCK202005	20	200	-	3.75 VA	-
	PCK202505	20	250	3.75 VA	3.75 VA	-
	PCK203505	20	300	3.75 VA	3.75 VA	-
PTK30S	PTK30S305	30	30	-	1.5VA(3PT)	-
	PTK30S405	30	40	-	1.5VA(3PT)	-
	PTK30S505	30	50	-	1.5VA(2PT)	-
	PTK30S605	30	60	-	2.5 VA(2PT)	-
	PTK30S805	30	80	-	2.5 VA(2PT)	-
	PTK30S1005	30	100	-	1.5 VA	-
	PTK30S1255	30	125	2.5 VA	2.5 VA	-
	PTK30S1505	30	150	2.5 VA	2.5 VA	-
	PTK30S1605	30	160	2.5 VA	2.5 VA	-
	PTK30S2005	30	200	3.75 VA	3.75 VA	-
	PTK30S2505	30	250	2.5 VA	2.5 VA	-
	PTK30S3005	30	300	3.75 VA	3.75 VA	-
PTK30	PTK30S4005	30	400	5 VA	5 VA	-
	PTK30605	30	60	-	1.5 VA	-
	PTK30805	30	80	-	1.5 VA	-
	PTK301005	30	100	2.5 VA	2.5 VA	-
	PTK301255P	30	125	-	2.5 VA	-
	PTK301505	30	150	2.5 VA	2.5 VA	-
	PTK301605	30	160	2.5 VA	2.5 VA	-
	PTK302005	30	200	2.5 VA	2.5 VA	-
	PTK302505	30	250	2.5 VA	2.5 VA	-
	PTK303005	30	300	-	5 VA	-
	PTK304005	30	400	5 VA	5 VA	-
	PTK305005	30	500	10 VA	10 VA	-
	PTK306005	30	600	5 VA	5 VA	-

CURRENT TRANSFORMER

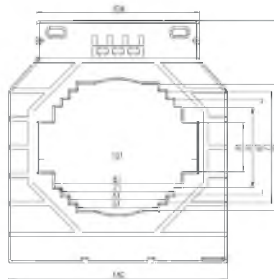
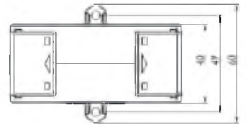
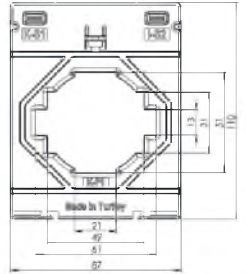
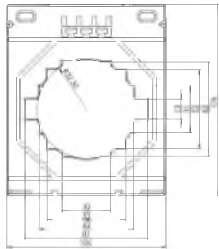
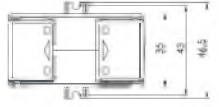
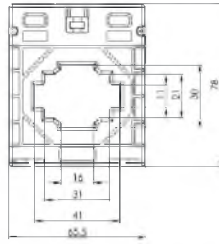

Description		Class				
Series	Code	Hole (mm)	Primary (A)	Class 0.5	Class 1.0	Class 3.0
PTK40	PTK402005	40	200	2.5 VA	2.5 VA	-
	PTK402505	40	250	2.5 VA	2.5 VA	-
	PTK403005	40	300	2.5 VA	3.75 VA	-
	PTK404005	40	400	5 VA	5 VA	-
	PTK405005	40	500	5 VA	5 VA	-
	PTK406005	40	600	5 VA	5 VA	-
	PTK408005	40	800	10 VA	10 VA	-
PTK60	PTK606005	60	600	10 VA	12.5 VA	-
	PTK608005	60	800	15 VA	15 VA	-
	PTK6010005	60	1000	15 VA	20 VA	-
	PTK6012005	60	1200	20 VA	25 VA	-
	PTK6012505	60	1250	20 VA	25 VA	-
PTK80	PTK808005	80	800	15 VA	20 VA	-
	PTK8010005	80	1000	15 VA	15 VA	-
	PTK8012005	80	1200	15 VA	20 VA	-
	PTK8012505	80	1250	15 VA	20 VA	-
	PTK8015005	80	1500	20 VA	25 VA	-
	PTK8016005	80	1600	20 VA	25 VA	-
	PTK8020005	80	2000	15 VA	25 VA	-
	PTK8025005	80	2500	30 VA	30 VA	-
PTK100	PTK10010005	100	1000	15 VA	20 VA	-
	PTK10012005	100	1200	10 VA	15 VA	-
	PTK10012505	100	1250	15 VA	15 VA	-
	PTK10015005	100	1500	10 VA	15 VA	-
	PTK10016005	100	1600	30 VA	15 VA	-
	PTK10020005	100	2000	30 VA	30 VA	-
	PTK10025005	100	2500	30 VA	40 VA	-
	PTK10030005	100	3000	30 VA	30 VA	-
	PTK10032005	100	3200	30 VA	30 VA	-
	PTK10040005	100	4000	30 VA	30 VA	-

CURRENT TRANSFORMER

Description				Class		
Series	Code	Hole (mm)	Primary (A)	Class 0.5	Class 1.0	Class 3.0
PLDK125	PLDK12512005	125	1200	20	30	-
	PLDK12512505	125	1250	30	30	-
	PLDK12515005	125	1500	15	20	-
	PLDK12516005	125	1600	15	20	-
	PLDK12520005	125	2000	25	30	-
	PLDK12525005	125	2500	30	30	-
	PLDK12530005	125	3000	-	30	-
	PLDK12532005	125	3200	30	30	-
	PLDK12540005	125	4000	30	40	-

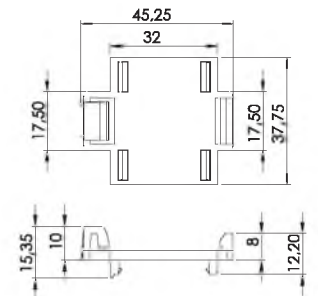
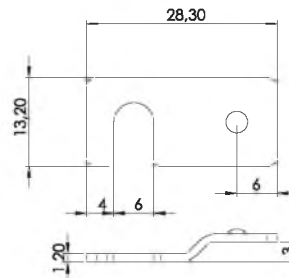
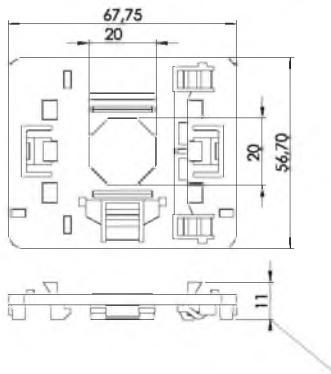
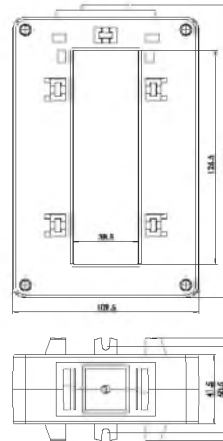

A.C. ANALOG METERS, 90°, X/1A, X/5A				
Series	Code	Product	Size	Scale
PAK	PAK-A72	AMPEREMETER	72x72 mm	0-500A
	PAK-V72	VOLTMETER	72x72 mm	300V 500V 600V
	PAK-A96	AMPEREMETER	96x96 mm	0-500A
	PAK-V96	VOLTMETER	96x96 mm	300V 500V 600V

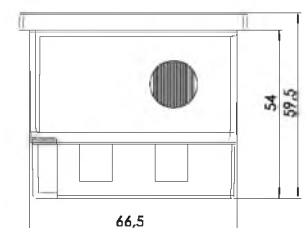
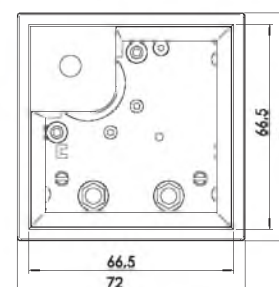
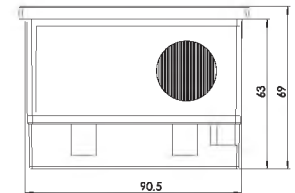
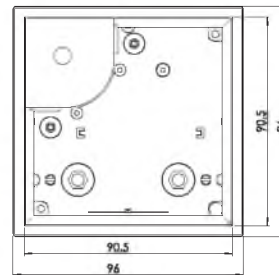



It has always been **Plastim**'s main principal to use the **highest technology** for its production

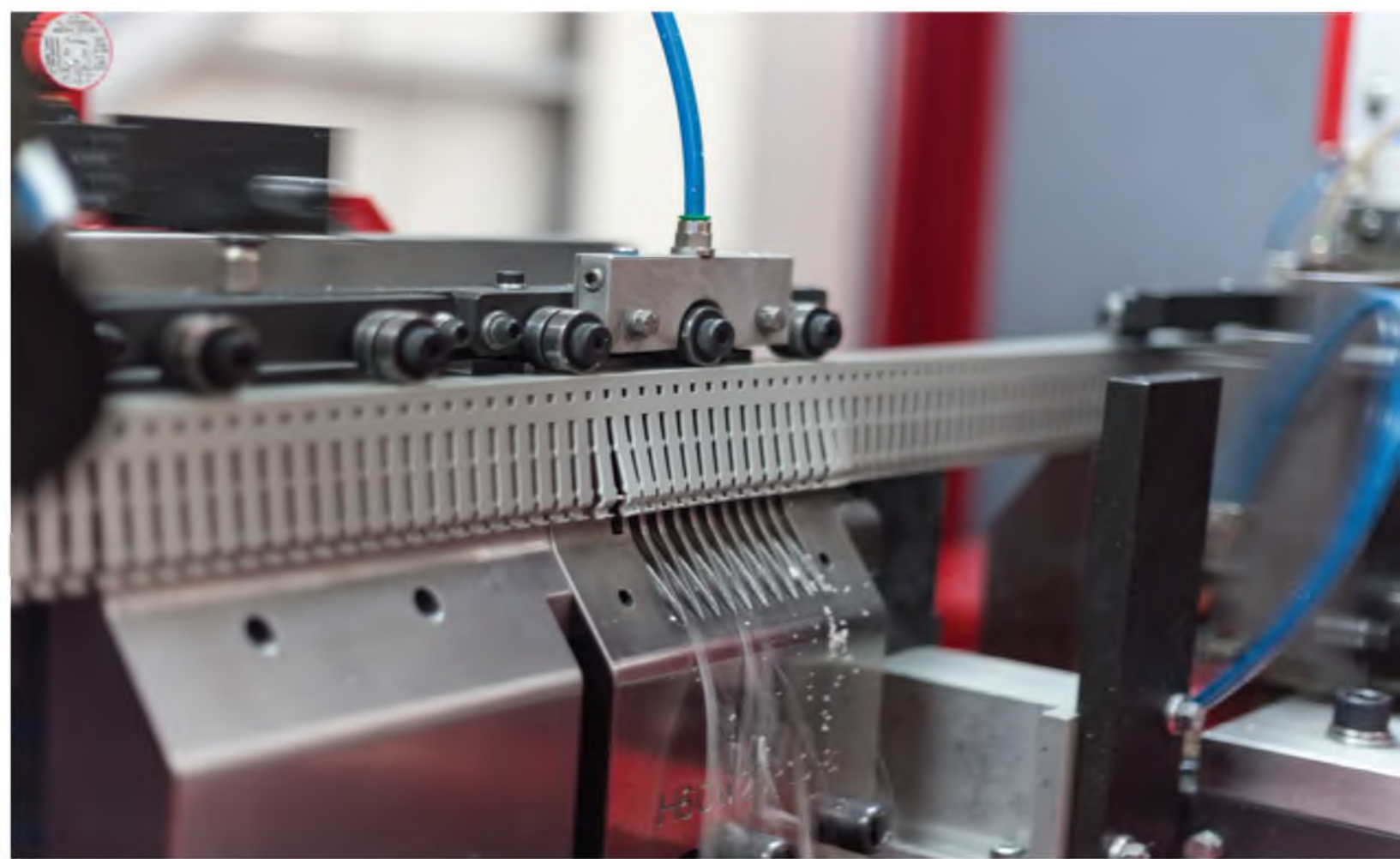

The **fastest**
cable duct punching machine
in the world (10mt/min)



Архангельск (8182)63-90-72
Астана (7172)727-132
Астрахань (8512)99-46-04
Барнаул (3852)73-04-60
Белгород (4722)40-23-64
Брянск (4832)59-03-52
Владивосток (423)249-28-31
Волгоград (844)278-03-48
Вологда (8172)26-41-59
Воронеж (473)204-51-73
Екатеринбург (343)384-55-89
Иваново (4932)77-34-06

Ижевск (3412)26-03-58
Иркутск (395)279-98-46
Казань (843)206-01-48
Калининград (4012)72-03-81
Калуга (4842)92-23-67
Кемерово (3842)65-04-62
Киров (8332)68-02-04
Краснодар (861)203-40-90
Красноярск (391)204-63-61
Курск (4712)77-13-04
Липецк (4742)52-20-81

Магнитогорск (3519)55-03-13
Москва (495)268-04-70
Мурманск (8152)59-64-93
Набережные Челны (8552)20-53-41
Нижний Новгород (831)429-08-12
Новокузнецк (3843)20-46-81
Новосибирск (383)227-86-73
Омск (3812)21-46-40
Орел (4862)44-53-42
Оренбург (3532)37-68-04
Пенза (8412)22-31-16

Пермь (342)205-81-47
Ростов-на-Дону (863)308-18-15
Рязань (4912)46-61-64
Самара (846)206-03-16
Санкт-Петербург (812)309-46-40
Саратов (845)249-38-78
Севастополь (8692)22-31-93
Симферополь (3652)67-13-56
Смоленск (4812)29-41-54
Сочи (862)225-72-31
Ставрополь (8652)20-65-13

Сургут (3462)77-98-35
Тверь (4822)63-31-35
Томск (3822)98-41-53
Тула (4872)74-02-29
Тюмень (3452)66-21-18
Ульяновск (8422)24-23-59
Уфа (347)229-48-12
Хабаровск (4212)92-98-04
Челябинск (351)202-03-61
Череповец (8202)49-02-64
Ярославль (4852)69-52-93

Киргизия (996)312-96-26-47

Россия (495)268-04-70

Казахстан (772)734-952-31

<https://plastim.nt-rt.ru/> || pit@nt-rt.ru